



LED34-CH

- Mid-IR LED
- 3.40 μm , 300 μW QCW
- TO-18 package
- Chalcogenide glass cover



Description

LED34-CH is a mid-infrared LED, based on InGaAs structure with a typical peak wavelength of 3.4 μm and optical output power of 300 μW @ 200 mA in **Quasi Continuous Wave (QCW) operating regime**. **LED34-CH** comes in TO-18 package with chalcogenide glass cover, and is primarily used for **gas sensing** and analyzing applications.

Maximum Ratings

Parameter	Symbol	Values		Unit
		Min.	Max.	
Forward Current, QCW	$I_{QCW\ max}$		200	mA
Forward Current, Pulsed	$I_{P\ max}$		1	A
Operating Temperature	T_{OPR}	0	+ 50	$^{\circ}\text{C}$
Storage Temperature	T_{STG}	0	+ 50	$^{\circ}\text{C}$
Lead Solder Temperature*	T_{SOL}		+ 180	$^{\circ}\text{C}$

* max time <3 s, min. 3 mm from case

Electro-Optical Characteristics ($T_{CASE} = 25^{\circ}\text{C}$)

Parameter	Symbol	Conditions	Values			Unit
			Min.	Typ.	Max.	
Peak Wavelength	λ_P	$I_{QCW}=150\ \text{mA}$	3.30		3.44	μm
Half Width	λ_{Δ}	$I_{QCW}=150\ \text{mA}$	250		600	nm
Forward Voltage	V_F	$I_{QCW}=200\ \text{mA}$	0.2		1.3	V
Output Power, QCW* ¹	P_{QCW}	$I_{QCW}=200\ \text{mA}$	100	300		μW
Output Power, Pulsed* ²	P_P	$I_P=1\ \text{A}$	700	2000		μW

*¹ Repetition rate: 0.5 kHz, pulse duration: 1000 μs , duty cycle: 50%

*¹ Repetition rate : 0.5 kHz, pulse duration: 20 μs , duty cycle: 1%





Performance Characteristics

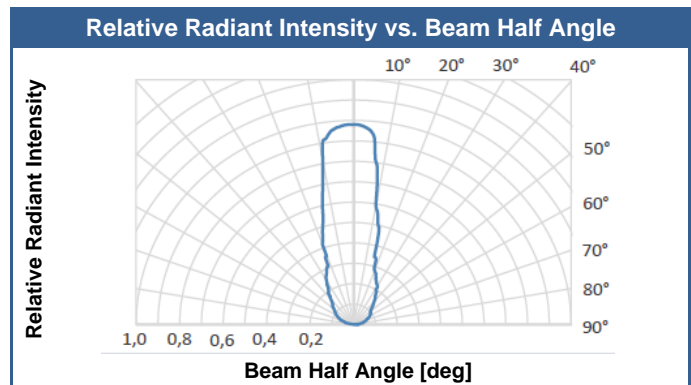
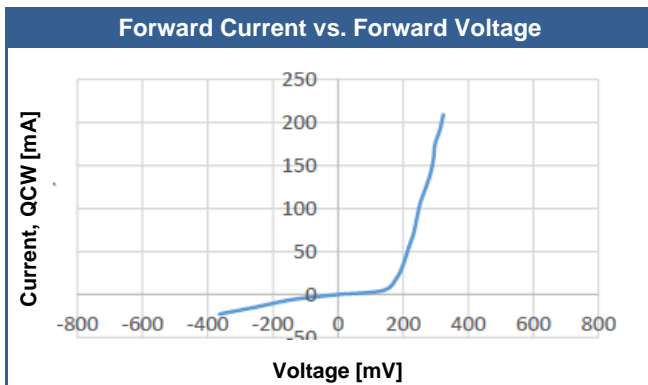
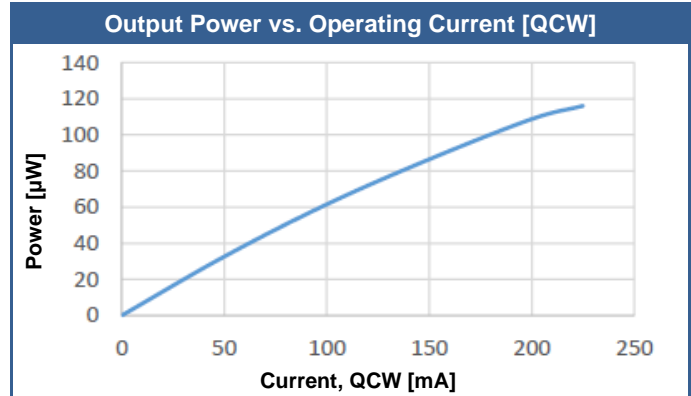
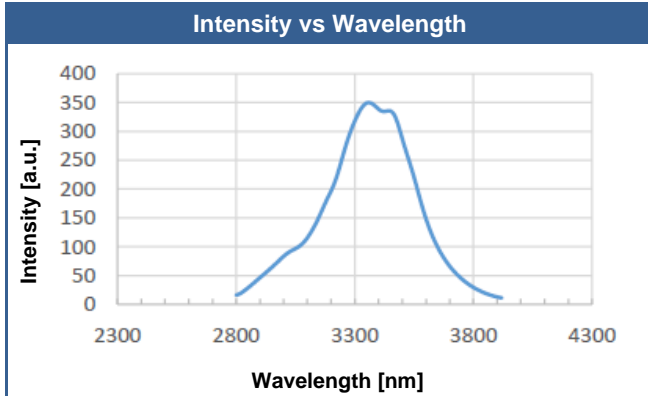

Operating Considerations

- Do check your connection circuit before turning on the LED
- Do check the LED polarity. Reverse voltage will damage the LED
LED anode is marked with a red dot on the rear side
- Do not connect the LED to a multimeter.
- Do not exceed maximum allowed currents
- Do not apply force to the chalcogenide glass cover
- Always do stay within the allowed temperature range.

We recommend to use **Quasi Continuous Wave (QCW) mode** with duty cycle 50% or 25% to obtain maximum average optical power and **short Pulse mode** to obtain maximum peak power. **Continuous Wave (CW) mode is NOT recommended**

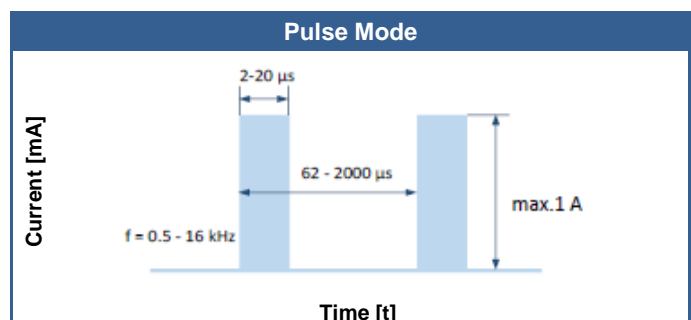
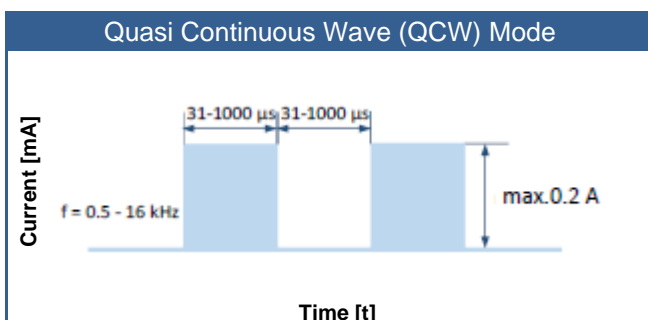



LED Recommended Circuit Connection.

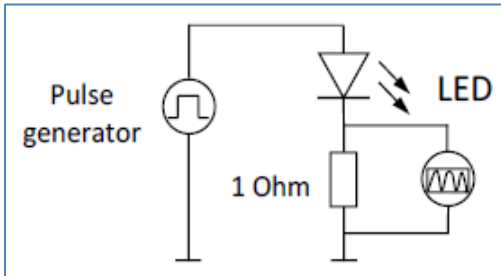

Outline Dimensions

TO-18

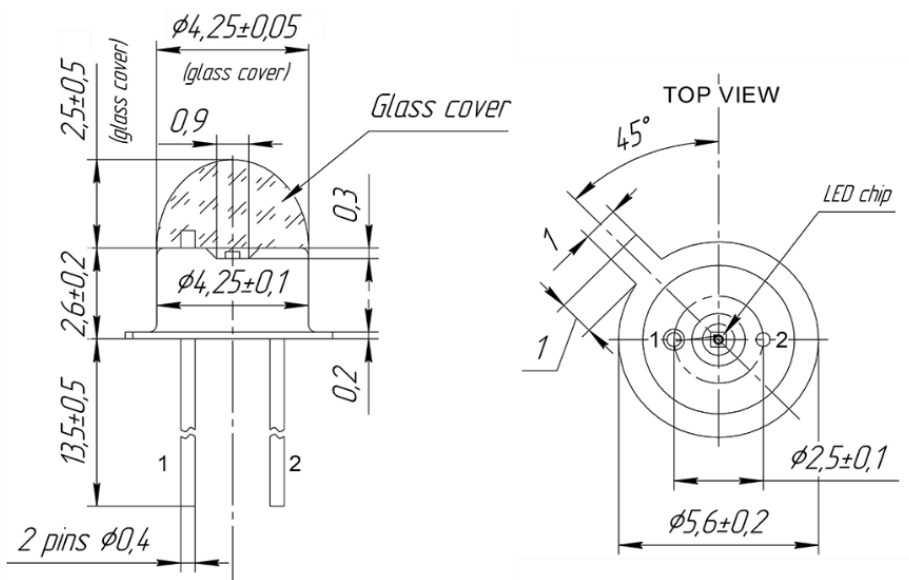

LED anode is marked with a red dot on the rear side

all dimensions in mm

© All Rights Reserved

The above specifications are for reference purpose only and subjected to change without prior notice