



## ACL7065

- Laser Diode Collimating Lens
- Acryl
- Uncoated

### Parameters

Parameter	Symbol	Values	Unit
Diameter	$\emptyset$	7.0	mm
Thickness		3.3	mm
Effective Focal Length	<i>EFL</i>	/	mm
Back Focal Length	<i>BFL</i>	6.47	mm

### Outline Dimensions

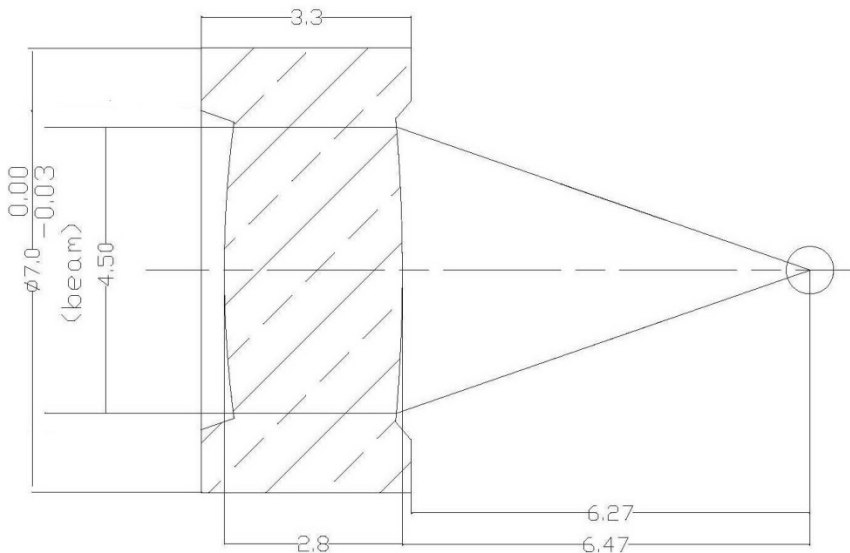

All dimensions in mm