



# ROITHNER LASERTECHNIK GmbH

WIEDNER HAUPTSTRASSE 76  
TEL. +43 1 586 52 43 -O. FAX. -44

1040 VIENNA AUSTRIA  
OFFICE@ROITHNER-LASER.COM



## S9850MG

- IR Laser Diode
- 980 nm, 50 mW, CW
- Single mode
- TO56 package, Flat Window



### Description



**S9850MG** is an IR laser diode, typically emitting at 980 nm, with an operating temperature range of up to 70°C. **S9850MG** comes in 5.6 mm TO-Can package **with integrated PD**.

### Maximum Rating\* (T<sub>CASE</sub> = 25°C)

Parameter	Symbol	Values		Unit
		Min.	Max.	
Optical Output Power*1	$P_{MAX}$		100	mW
Reverse Voltage	$V_R$		2	V
Operating Temperature*1	$T_{OPR}$	- 10	+ 70	°C
Storage Temperature	$T_{STG}$	- 40	+ 85	°C
Soldering Temperature (max. 3s)	$T_{SOL}$		+ 260	°C

\*1 operating at maximum ratings may influence the life time

### Electro-Optical Characteristics (T<sub>CASE</sub> = 25°C)

Parameter	Symbol	Values			Unit
		Min.	Typ.	Max.	
<b>Peak Wavelength</b>	$\lambda_P$	<b>965</b>	<b>980</b>	<b>990</b>	<b>nm</b>
<b>Optical Output Power</b>	$P_O$		<b>50</b>		mW
Operating Voltage	$V_F$		1.55	2.0	V
Threshold Current	$I_{th}$		12	20	mA
Operating Current	$I_F$		75	90	mA
Slope Efficiency	$\eta$	0.64	0.8		W/A
PD Current	$I_{PD}$	0.1	0.3	0.5	mA
Beam Divergence (FWHM)	parallel	$\Theta_{  }$	10		deg.
	perpendicular	$\Theta_{\perp}$	35		deg.



### Electrical Connection

#### Pin Configuration

Pin #	Function
Pin 1	LD Cathode
Pin 2	LD Anode, PD Cathode
Pin 3	PD Anode

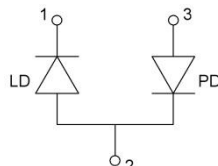

#### Bottom View

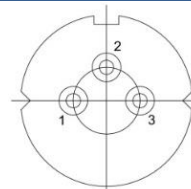



## Performance Characteristics

### Optical Output Power vs. Forward Current

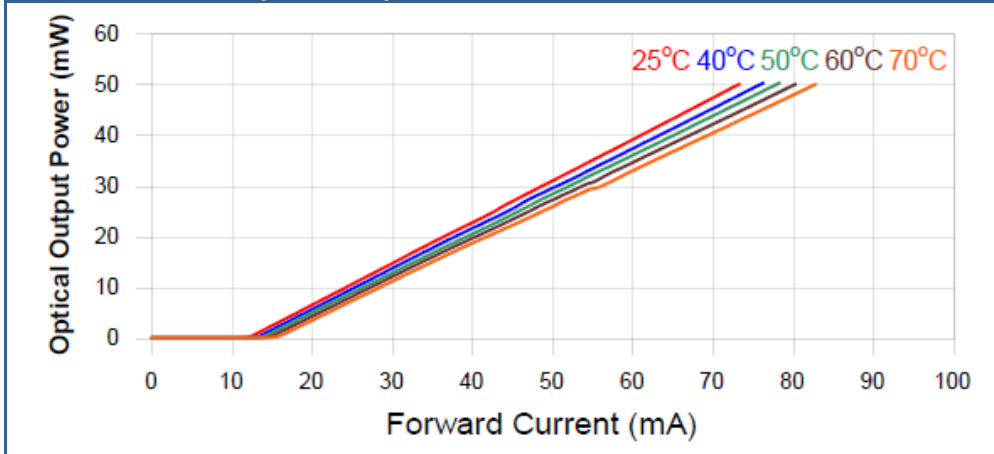

### Forward Voltage vs. Forward Current

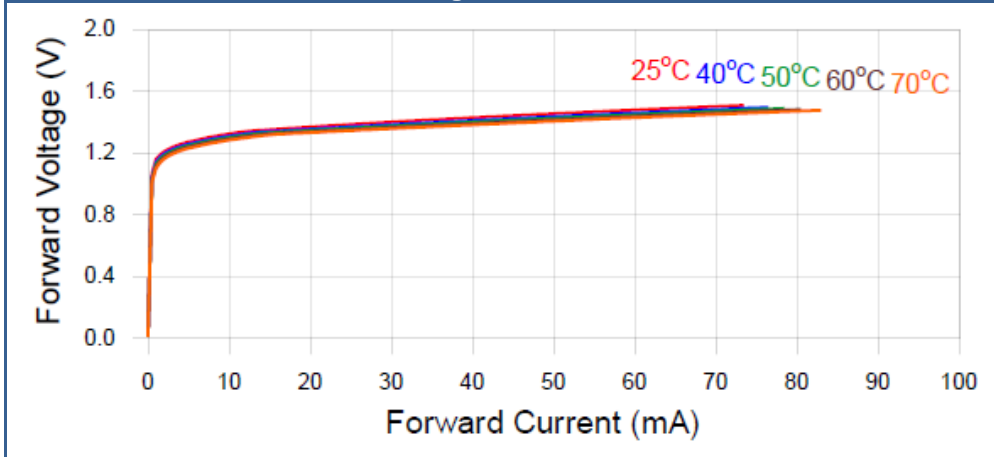

### Peak Wavelength vs. Case Temperature

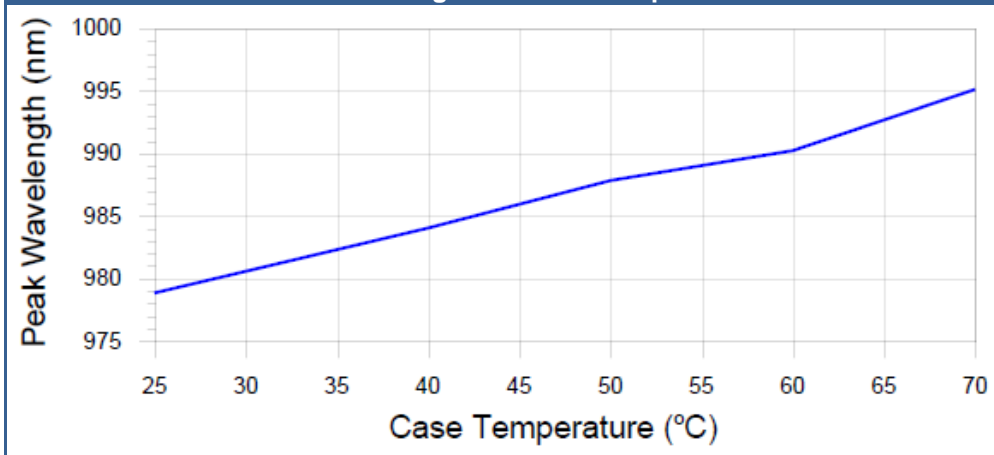



## Performance Characteristics

### Monitor Current vs. Optical Output Power

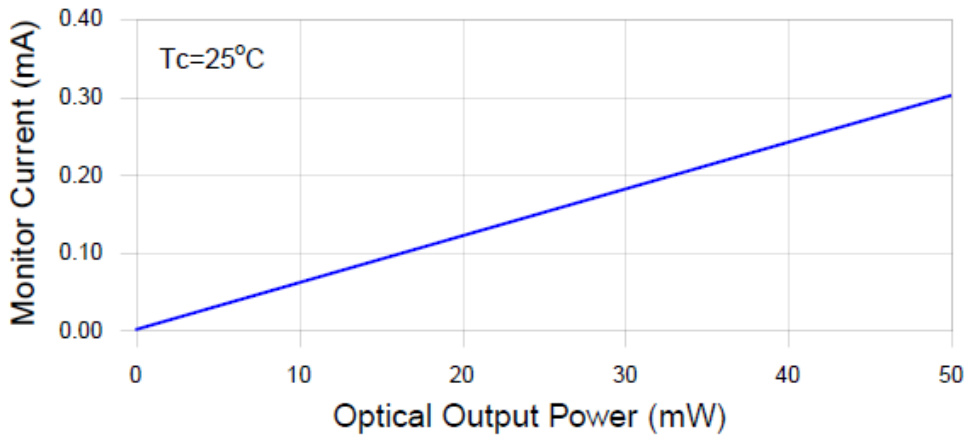

### Slope Efficiency vs. Case Temperature

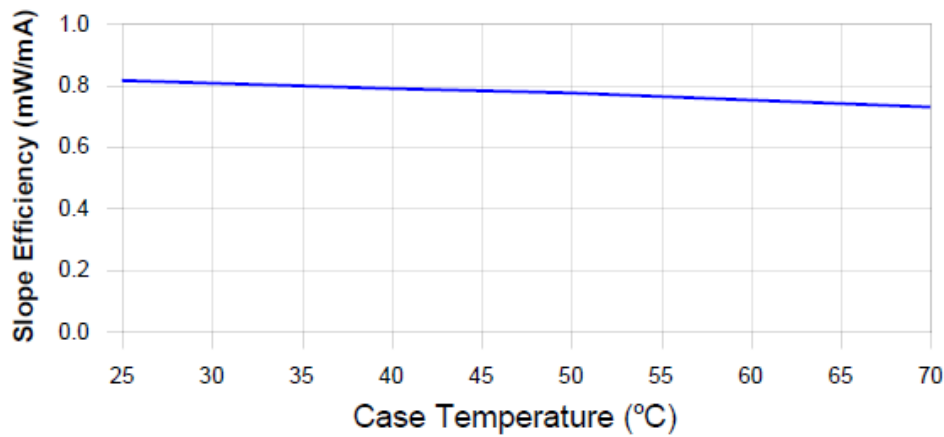

### Threshold Current vs. Case Temperature

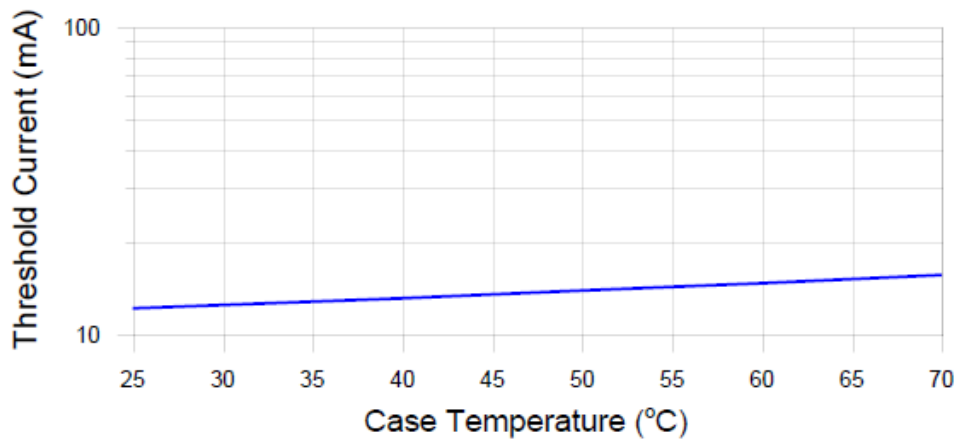



## Outline Dimensions

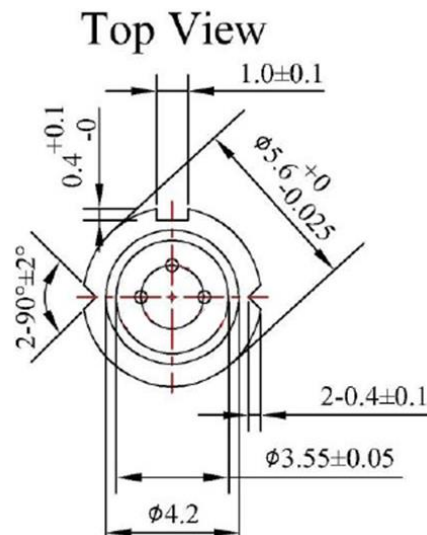
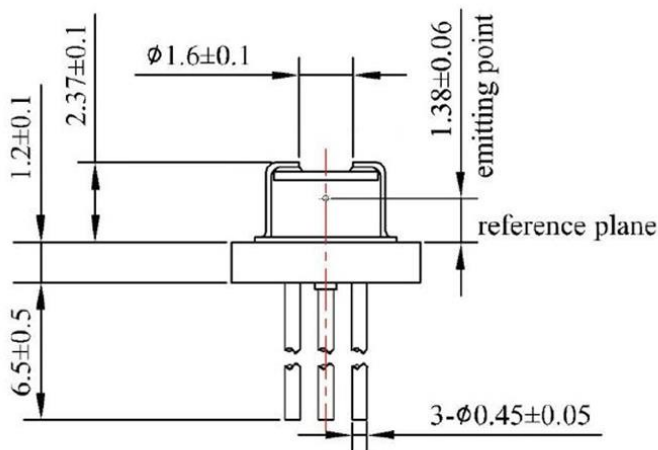

All dimensions in mm

## Precautions

### Safety

**Caution:** Laser light emitted from any laser diode may be **harmful to the human eye**. Avoid looking directly into the laser diode's aperture when the diode is in operation.

**Note:** The use of optical lenses with this laser diode will increase eye hazard

### ESD caution

Always do handle laser diodes with extreme care to **prevent electrostatic discharge**, the primary cause of unexpected diode failure. To prevent ESD related failures, it is strongly advised to always **wearing wrist straps**, and **grounding all applicable work surfaces**, when handling laser diodes

### Operating Considerations

It is strongly advised to only operate this laser diode with a current source. The current of a laser diode is an exponential function of the voltage across it. **Usage of current regulated drive circuits is mandatory.** Laser diodes may be damaged by excessive drive currents or switching transients

It is advised, to operate the laser diode at the lowest temperature possible, and to never exceed maximum specifications as outlined in the datasheet. Device degradation will accelerate with increased temperature. **Proper heat sinking will greatly enhance stability and life time of the laser diode**