



# ROITHNER LASERTECHNIK GmbH

WIEDNER HAUPTSTRASSE 76  
TEL. +43 1 586 52 43 -0, FAX. -44

1040 VIENNA AUSTRIA  
OFFICE@ROITHNER-LASER.COM



## RLT1310-20MGS

- Infrared DFB Laser Diode
- 1310 nm, 20 mW
- Single transverse mode
- 5.6mm TO-Can with Flat Window



### Description

**RLT1310-20MGS** is an infrared **distributed feedback (DFB)** laser diode, with **single transverse mode** emission at typically 1310 nm and low operating current. **RLT1310-20MGS** comes in 5.6 mm TO-Can with flat window and **integrated PD**.

### Maximum Rating\* ( $T_{CASE} = 25^{\circ}C$ )

Parameter	Symbol	Values		Unit
		Min.	Max.	
Reverse Voltage	$V_R$		2	V
Operating Temperature*	$T_{OPR}$	- 20	+ 50	$^{\circ}C$
Storage Temperature*	$T_{STG}$	- 40	+ 85	$^{\circ}C$
Soldering Temperature (max. 3s)	$T_{SOL}$		+ 260	$^{\circ}C$

\* operating close to or outside these conditions may damage the device

### Electro-Optical Characteristics ( $T_{CASE} = 25^{\circ}C$ )

Parameter	Symbol	Values			Unit
		Min.	Typ.	Max.	
<b>Peak Wavelength</b>	$\lambda_P$	<b>1300</b>	<b>1310</b>	<b>1320</b>	<b>nm</b>
<b>Optical Output Power</b>	$P_O$		<b>30</b>		mW
Spectral Width (FWHM)	$\lambda$			3	nm
Operating Voltage	$V_F$		1.4		V
Threshold Current	$I_{th}$		10		mA
Operating Current	$I_F$		75		mA
Beam Divergence (FWHM)	parallel	$\Theta_{  }$	9		deg.
	perpendicular	$\Theta_{\perp}$	20		deg.
PD Current	$I_M$		1		mA



### Electrical Connection

#### Pin Configuration

Pin #	Function
Pin 1	PD anode
Pin 2	LD anode
Pin 3	LD cathode
Pin 4	PD cathode

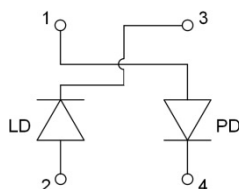

#### Bottom View

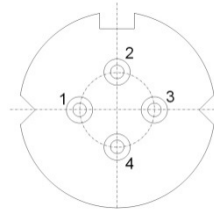



## Outline Dimensions

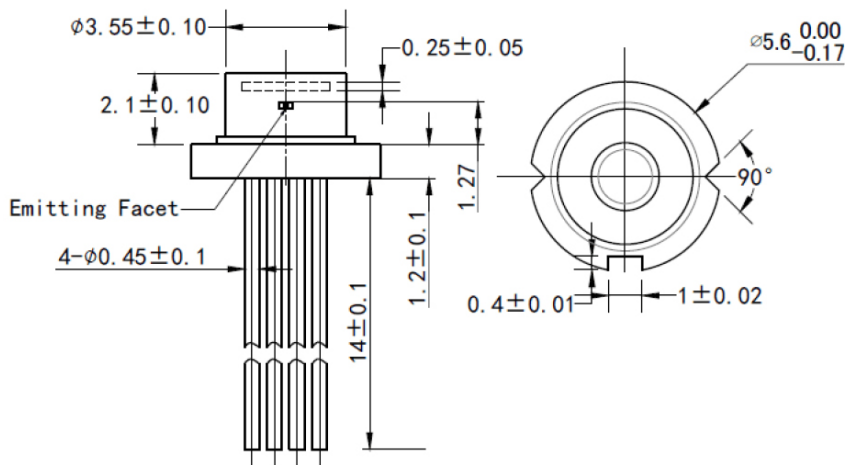

All dimensions in mm

## Precautions

### Safety

**Caution:** Laser light emitted from any laser diode may be **harmful to the human eye**. Avoid looking directly into the laser diode's aperture when the diode is in operation.

**Note:** The use of optical lenses with this laser diode will increase eye hazard

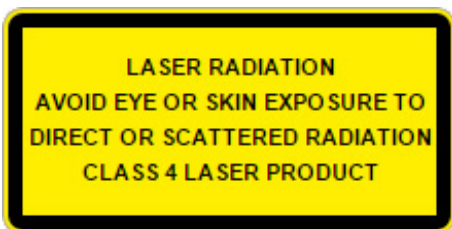

### ESD caution

Always do handle laser diodes with extreme care to **prevent electrostatic discharge**, the primary cause of unexpected diode failure. To prevent ESD related failures, it is strongly advised to always **wearing wrist straps**, and **grounding all applicable work surfaces**, when handling laser diodes

### Operating Considerations

It is strongly advised to only operate this laser diode with a current source. The current of a laser diode is an exponential function of the voltage across it. **Usage of current regulated drive circuits is mandatory.** Laser diodes may be damaged by excessive drive currents or switching transients

It is advised, to operate the laser diode at the lowest temperature possible, and to never exceed maximum specifications as outlined in the datasheet. Device degradation will accelerate with increased temperature. **Proper heat sinking will greatly enhance stability and life time of the laser diode**