



## AS081Q3000W



### TECHNICAL DATA

## High Power Stacked Infrared Laser Diode Array

#### Features

- Output Power: 3000 W qCW
- 780-830 nm Emission Wavelength
- Spectral Width:  $\leq 4$  nm
- High Reliability, High Efficiency
- QCW stack can be designed according to the customer of non-standard products heat sink package

#### Applications

- Laser Pumping
- Medical Usage
- High power laser diode applications

#### Specifications (25°C)

Item	Symbol	Value	Unit
<b>Optical Specifications</b>			
qCW Output Power	$P_O$	3000	W
qCW Output Power / Bar	$P_S$	100	W
Array Length	L	10	mm
Center Wavelength	$\lambda_C$	780-830	nm
Wavelength Tolerance		$\pm 5$	nm
Spectral Width	$\Delta\lambda$	$\leq 4$	nm
Package Style		Micro Channel	
Bar Length		0.5	mm
Number of Bars		30	
Wavelength Temperature Coefficient		0.3	nm/°C
Beam Divergence	$\theta_{\perp} \times \theta_{\parallel}$	40x8	deg
<b>Electrical Specifications</b>			
Slope Efficiency	$E_S$	$\geq 1$	W/A
Conversion Efficiency	$N_S$	$\geq 40\%$	
Threshold Current	$I_{TH}$	$\leq 25$	A
Operating Current	$I_F$	$\leq 120$	A
Operating Voltage	$U_F$	$\leq 60$	V
<b>Absolute Maximum Ratings</b>			
Reverse Voltage	$U_R$	2.5	V
Operating Temperature	$T_{OP}$	+10 ... +40	°C
Storage Temperature	$T_{STG}$	-40 ... +85	°C





## Package Dimensions

### Micro Channel (Unit:mm)

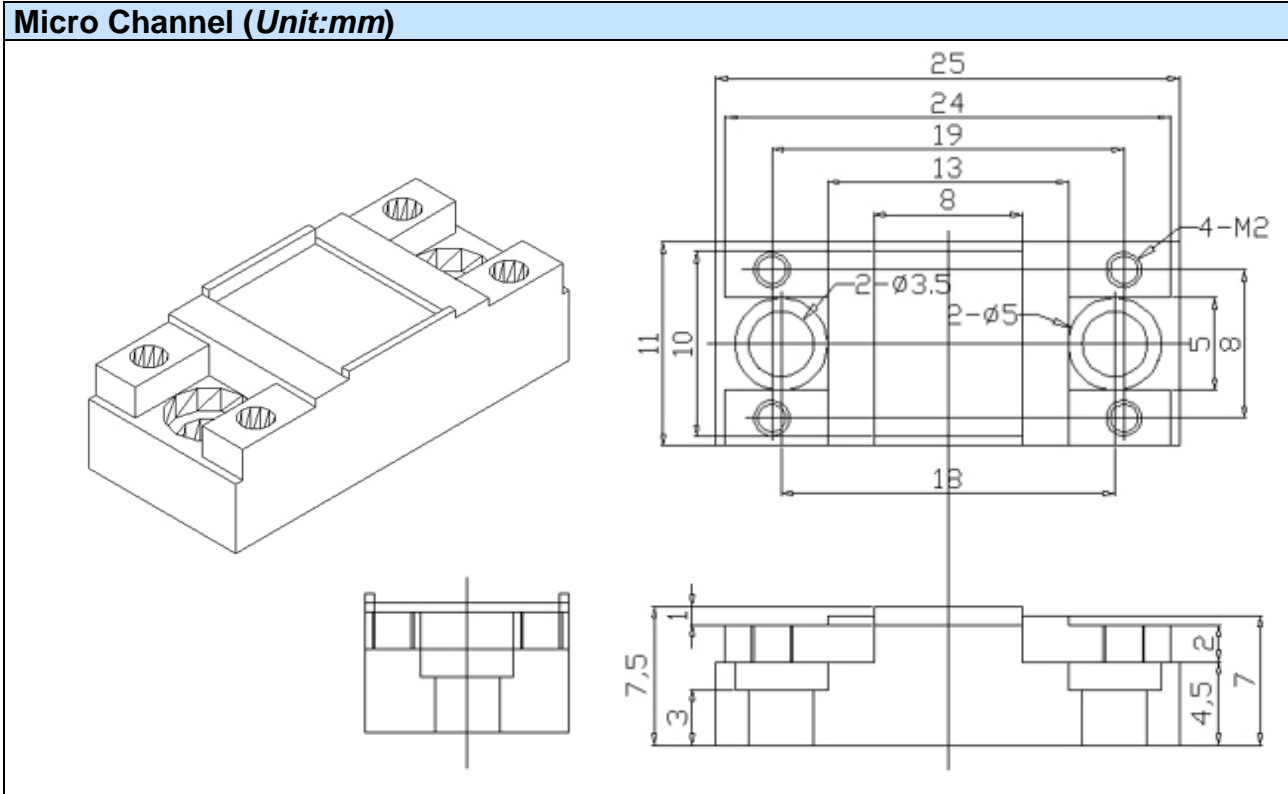

## Notes

1. Caution! Don't look at the laser beam directly, because it's harmful to eyes.
2. The storage temperature is between -40 and 85 °C.
3. Under normal circumstances, the higher the temperature is, the shorter the life of semiconductor laser will be. It is recommended to use lasers under TEC cooling or in air-conditioned room.
4. To use a laser diode in following sequences: Turn on the power supply; connect to the laser diode; and then increase the current gradually to the specified operating value. To shut down the laser diode, please decrease the current to zero gradually, and then turn off the power. Please make sure that the power supply has no current overshoot at any time. The current overshoot can damage the laser diodes permanently.
5. The high power laser diode arrays are very sensitive to electrostatic. Please wear anti-static bracelet during operating with the laser diodes (arrays).
6. Be sure that the operating current does not exceed the specified operating current. Otherwise, it will accelerate laser aging, shorten lifetime or even damage devices permanently.
7. A clean, dry and ventilated environment should be available when storing and operating laser diodes (arrays). Dust may degrade the laser diodes (arrays).
8. Constant-current power supply with voltage regulator should be used to avoid surge.