

SPECIFICATION FOR LED LAMP

MODEL : LC503MUV1-30Q
REF. : A 01F09

DESCRIPTIONS:

30 DEGREE 5MM LED LAMP
IN VIOLET COLOR WITH
WATER TRANSPARENT LENS
AND NO STOPPER

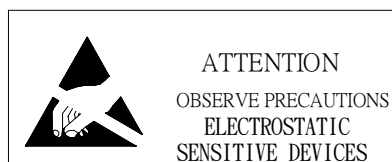

DOC. NO. :	SPE/LC503MUV1-30Q
REF:	A 01F09

DIMENSION DRAWING

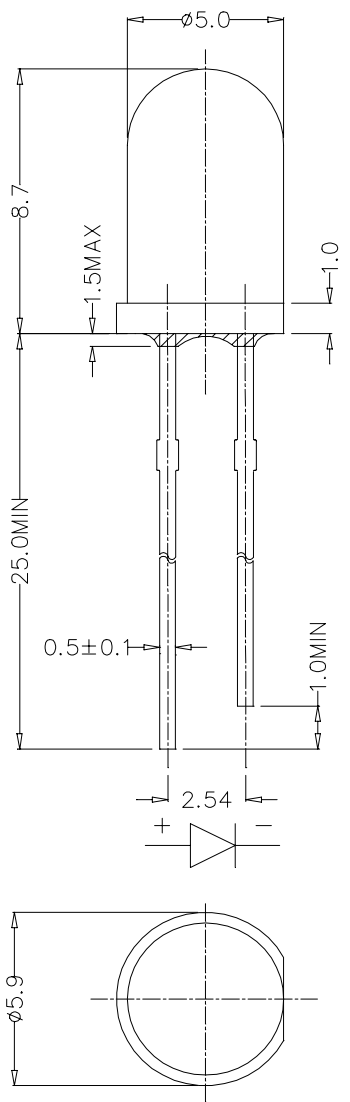

- NOTES:1. ALL DIMENSIONS ARE IN mm TOLERANCE IS.±0.25mm UNLESS OTHERWISE NOTED.
2. AN EPOXY MENISCUS MAY EXTEND ABOUT 1.5mm DOWN THE LEADS.
3. BURR AROUND BOTTOM OF EPOXY MAY BE 0.5 mm MAX.

Scale 4 : 1		Allow 0.25	
Title: OUTLINE DIMENSION	Date:	Units: mm	
Model #	LC503MUV1-30Q	Checked	Approved
ECN#		Drawn	

MATERIALS	Epoxy	Water Transparent	Ag Plating	Iron Alloy	InGaN/SiC
ITEM	Resin (Mold)	Lens Color	Lead Frame	Dice	

DOC. NO. :	SPE/LC503MUV1-30Q
REF:	A 01F09

These specification shall be applied to the LED model # LC503MUV1-30Q

SPECIFICATION

Absolute Maximum Rating (T_a = 25°C)

Items	Symbol	Absolute maximum Rating	Unit
Forward Current	I _F	30	mA
Peak Forward Current pulse width ≤ 0.1msec duty ≤ 1/10	I _{FP}	100	mA
Reverse Voltage	V _R	5	V
Power Dissipation	P _D	120	mW
Operation Temperature	T _{opr}	-20 ~ + 80	°C
Storage Temperature	T _{stg}	-30 ~ +100	°C
Lead Soldering Temperature	T _{sol}	260°C for 3sec (3mm from the base of the epoxy bulb)	

Initial Electrical/Optical Characteristics (T_a = 25°C)

Items	Symbol	Condition	Min.	Typ.	Max.	Unit
Forward Voltage	V _F	I _F = 20mA	3.2	3.7	4.2	V
Reverse Current	I _R	V _R = 5V	---	---	100	μA
Wavelength	λ _D	I _F = 20mA	380	390	400	nm
Luminous Efficacy	η	I _F = 20mA	---	2.8	---	lm/W
Radiometric Intensity	I _e	I _F = 20mA	12.4	25	---	mW/sr
50% Power Angle	2θ _½	I _F = 20mA	---	30	---	deg

Rank Combination

Rank	M	N	P	Q	R	S
Radiometric Intensity (mW/sr I _F = 20mA)	12.4-14.9	14.9-17.8	17.8-21.4	21.4-25.7	25.7-30.8	30.8-37.0

*One normal delivery will include all ranks listed above.

The quantity ratio of the ranks is decided

Measurement Uncertainty of the radiometric intensity : ±15%

DOC. NO. :	SPE/LC503MUV1-30Q
REF:	A 01F09

RELIABILITY

Test Items And Results

Type	Test Item	REF. Standard	Test Condition	Note	Number of Damaged
Environmental Sequence	Temperature Cycle	JIS C 7021 (1977)A-4	-20°C ⇒ 25°C ⇒ 80°C ⇒ 25°C 30mins, 5mins, 30mins, 5mins	100 cycles	0 / 100
	Thermal Shock	MIL-STD-107D	-20°C ⇒ 80°C 15mins, 15mins	100 cycles	0 / 100
	High Humidity Heat Cycle	JIS C 7021 (1977)A-5	30°C ⇒ 65°C 90%RH 24hrs/1cycle	10 cycles	0 / 100
	High Temperature Storage	JIS C 7021 (1977)B-10	T _a = 80°C	1000hrs	0 / 100
	Humidity Heat Storage	JIS C 7021 (1977)B-11	T _a = 60°C RH = 90%	1000hrs	0 / 100
	Low Temperature Storage	JIS C 7021 (1977)B-12	T _a = -30°C	1000hrs	0 / 100
Operation Sequence	Life Test	JIS C 7035 (1985)	T _a = 25°C I _F = 20mA	1000hrs	0 / 100
	High Humidity Heat Life Test	*	60°C RH=90% I _F = 20mA	500hrs	0 / 100
	Low Temperature Life Test	*	T _a = -20°C I _F = 20mA	1000hrs	0 / 100
Destructive Sequence	Resistance to Soldering Heat	JIS C 7021 (1977)A-11	T _{sol} = 260±5°C , 10sec (3mm from the base of the epoxy bulb)	1 time	0 / 20
	Solderability	JIS C 7021 (1977)A-2	T _{sol} = 235±5°C , 5sec (using flux)	1 time (over 95%)	0 / 20
	Lead Pull/Bend Test	JIS C 7021 (1977)A-11	Load 2.5N (0.25kgf) 0° ⇒ 90° ⇒ 0° bend 3 times	No noticeable damage	0 / 20

*Refer to reliability test standard specification for in this line.

Criteria for Judging The Damage

Item	Symbol	Test Condition	Criteria for Judgment	
			Min.	Max.
Forward Voltage	V _F	I _F = 20mA	---	Initial Data ×1.1
Reverse Current	I _R	V _R = 5V	---	100 μA
Radiometric Intensity	I _e	I _F = 20mA	Initial Data ×0.7	---

DOC. NO. :	SPE/LC503MUV1-30Q
REF:	A 01F09

GRAPHS

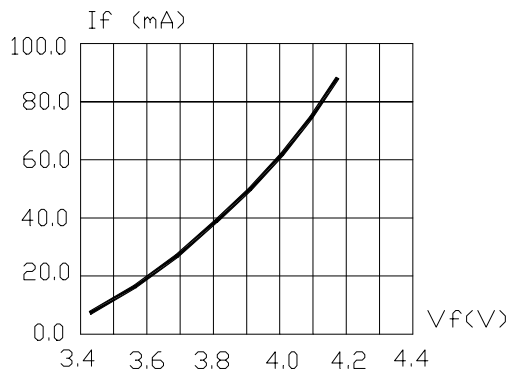

FIG.1 FORWARD CURRENT VS. FORWARD VOLTAGE.

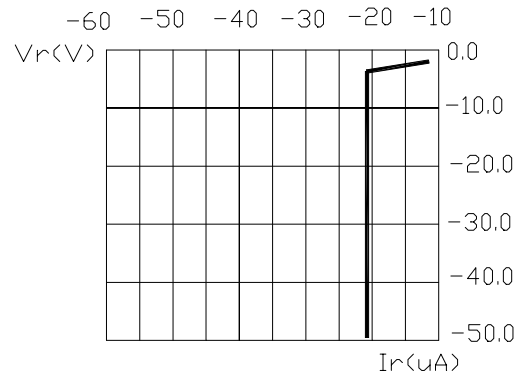

FIG.2 REVERSE CURRENT VS. REVERSE VOLTAGE.

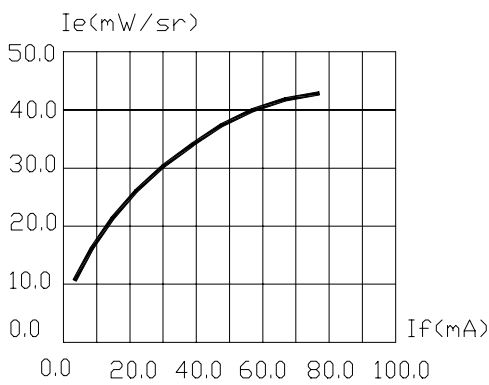

FIG.3 RELATIVE RADIOMETRIC INTENSITY VS. FORWARD CURRENT.

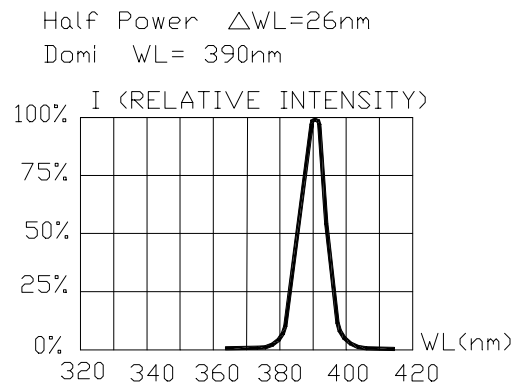

FIG.4 RELATIVE INTENSITY VS. WAVE LENGTH.

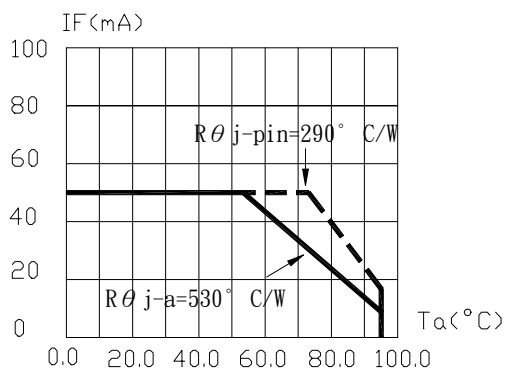

FIG.5 MAXIMUM FORWARD DC CURRENT VS TEMPERATURE. DERATING BASED ON $T_{jmax}=105^{\circ}$ C

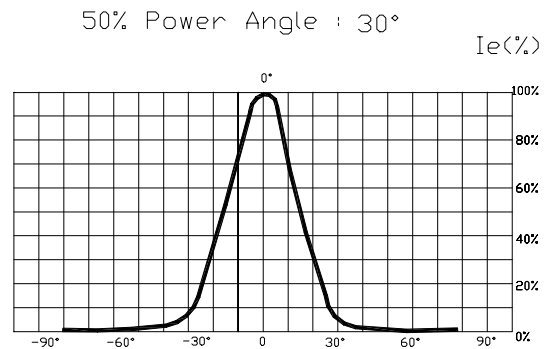

FIG.6 SPATIAL DISTRIBUTION.

- 1.Cathode PAD Area (0.18 \times 0.18inch²)
- 2.Height above nominal seating plane in inches(0.3inch)

