

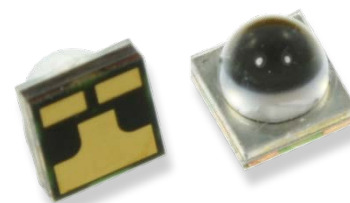

## UVR280-SA3

- Deep Ultraviolet Light Emission Source
- 280 nm, 10 mW
- All Metal Design
- Beam Angle 30 deg.



### Description

**UVR280-SA3** is an AlGaIn based single emitter **DEEP-UV LED** with a typical peak wavelength of **280 nm** and an optical output power of **10 mW** at a current of **150 mA**. It comes in an all metal 4545 SMD package with low thermal resistance. **UVR280-SA3** is ready for reflow soldering process, and can be delivered on tape and reel.

### Maximum Rating ( $T_{CASE} = 25^{\circ}C$ )

Parameter	Symbol	Values		Unit
		Min.	Max.	
Power Dissipation, DC	$P_D$		1500	mW
Forward Current*	$I_F$		150	mA
Thermal Resistance (junction-case)	$R_{thv}$		15	$^{\circ}C/W$
Operating Temperature*	$T_{OPR}$	- 40	+ 60	$^{\circ}C$
Storage Temperature	$T_{STG}$	- 40	+ 100	$^{\circ}C$
Soldering Temperature (max. 5s)	$T_{SOL}$		260	$^{\circ}C$

\* Operation close to the absolute maximum ratings may affect device reliability



### Electro-Optical Characteristics ( $T_{CASE} = 25^{\circ}C, I_F = 150 mA$ )

Parameter	Symbol	Values			Unit
		min.	typ.	max.	
Peak Wavelength*	$\lambda_P$	275		285	nm
<b>Radiated Power**</b>	<b><math>P_O</math></b>	<b>8</b>	<b>10</b>		<b>mW</b>
Spectral Width (FWHM)	$\Delta\lambda$		15		nm
Forward Voltage	$V_F$		8		V
<b>Viewing Angle</b>	<b><math>2\theta_{1/2}</math></b>		<b>30</b>		<b>deg.</b>

\*Peak Wavelength measurement tolerance is  $\pm 3nm$

\*\*Radiated power measurement tolerance is  $\pm 10\%$

### Electrical Connection

Pad	Function
1	Cathode
2	Anode
3	Heat Sink

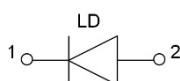

Bottom View:

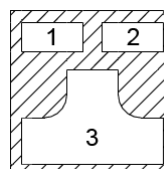



## Outline Dimensions

### SMD

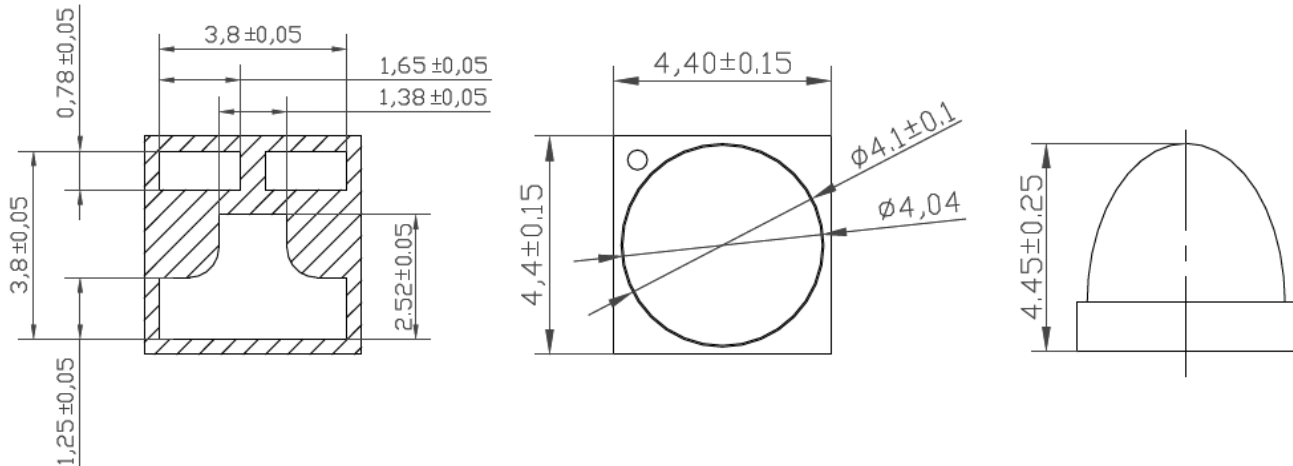

all dimensions in mm

## Performance Characteristics

### Forward Current vs. Forward Voltage

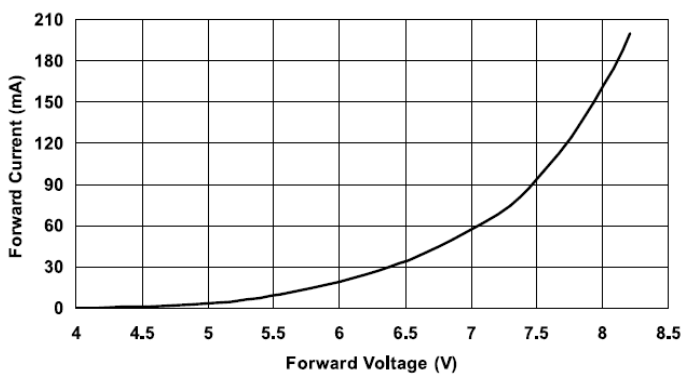

### Relative Intensity vs. Forward Current

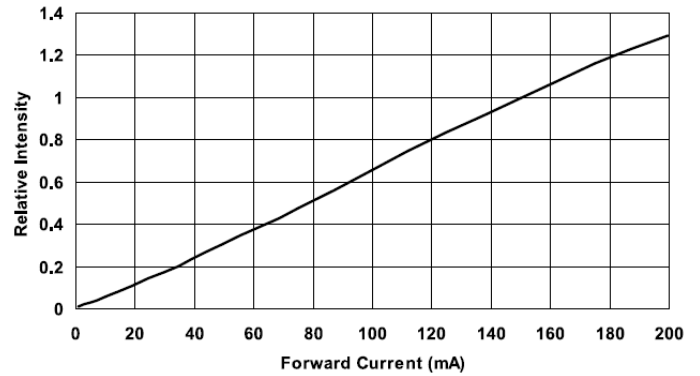

### Spectrum

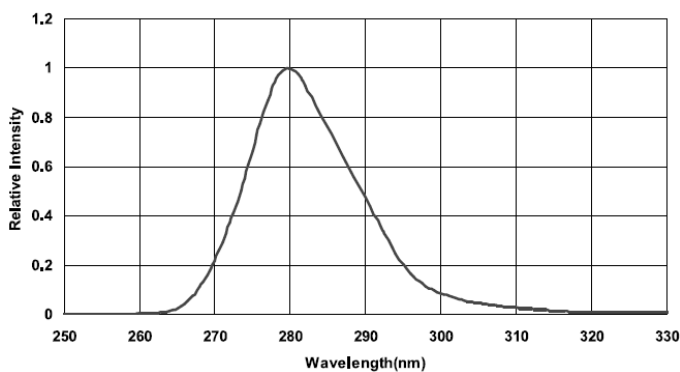

### Radiation Pattern

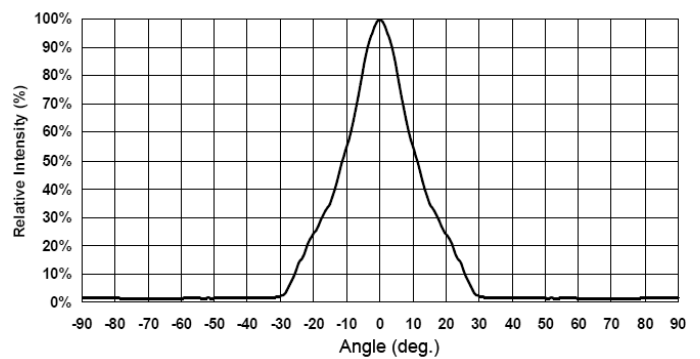



## Precautions

### Recommended Reflow Soldering Profile

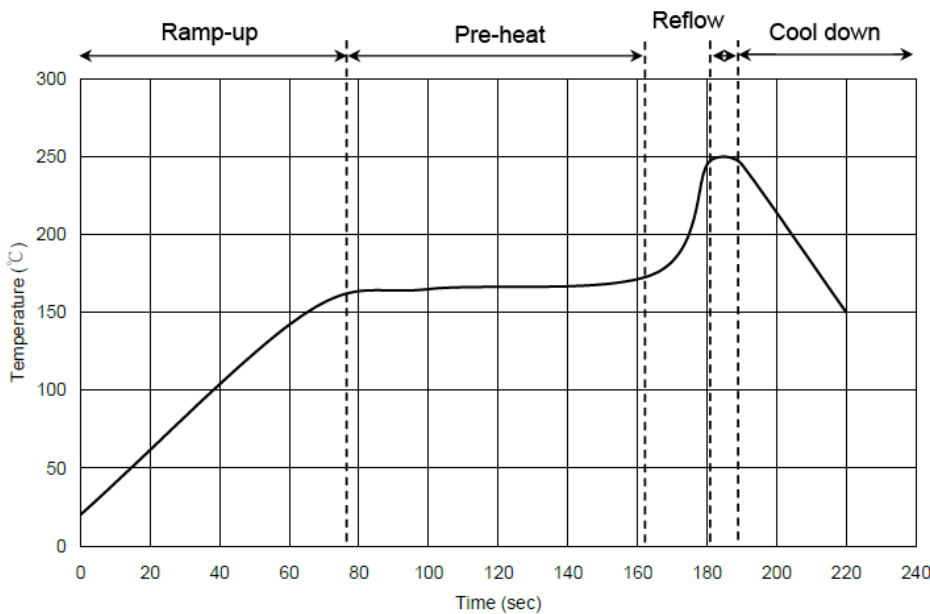

Process	Parameter
Ramp-up rate	< 3 °C/s
Ramp-up time	50-80 s
Pre-heat temp.	150-180 °C
Pre-heat time	< 120 s
Reflow time	< 10 s
Reflow ramp rate	< 2 °C/s
Reflow temp	< 250 °C
Cool down rate	< 5 °C/s

### Static Electricity

**LEDs are sensitive to electrostatic discharge (ESD).** Precautions against ESD must be taken when handling or operating these LEDs. Surge voltage or electrostatic discharge can result in complete failure of the device.

### UV-Radiation

During operation these LEDs do emit **high intensity ultraviolet light**, which is hazardous to skin and eyes, and may cause cancer. Do avoid exposure to the emitted UV light. **Protective glasses are recommended.** It is further advised to attach a warning label on products/systems that do utilize UV-LEDs:

### Operation

**Do only operate LEDs with a current source.**

Running these LEDs from a voltage source *will* result in complete failure of the device.

Current of a LED is an exponential function of the voltage across it. Usage of current regulated drive circuits is mandatory



### Cleaning

For **cleaning**, it is advised to use alcohol based solvents like **isopropyl alcohol**