

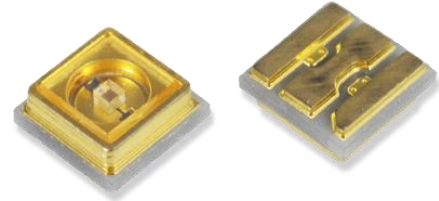

GD35R-310Z-F

- UVC High Power LED
- 310 nm, 3 mW
- 3535 SMD Package
- Quartz Glass Window
- Viewing Angle 120°



Description

GD35R-310Z-F is an **ultraviolet** light emission source, typically emitting at **310 nm (UVC)** with an optical output power of typically **3 mW** and narrow bandwidth. The hermetically sealed ceramic SMD package features a flat **quartz glass window** and integrated Zener diode for ESD protection. **Printed circuit boards (PCB)** are available for evaluation and prototyping (see page 3)

Absolute Maximum Ratings

Parameter	Symbol	Value		Unit
		min.	max.	
Reverse Current ($V_R=5V$)	I_R		10	μA
Forward Current	I_F		60	mA
Forward Pulse Current*	I_{FP}		100	mA
Operating Temperature	T_{OPR}	- 40	+ 85	$^{\circ}C$
Storage Temperature	T_{STG}	- 40	+ 100	$^{\circ}C$
Soldering Temperature (max.10 s)	T_{SOL}		240	$^{\circ}C$

*duty cycle 10%, pulse length 100 μs



Electro-Optical Characteristics ($T_{CASE} = 25^{\circ}C$)

Parameter	Symbol	Values			Unit
		min.	typ.	max.	
Peak Wavelength	λ_P	310		315	nm
Output Power	P_O	2	3		mW
Forward Voltage	V_F	5.0		7.0	V
Forward Current	I_F		40		mA
Beam Angle	$2\theta_{1/2}$		120		deg.
Thermal Resistance	R_{th}		6.5		$^{\circ}C/W$



Performance Characteristics ($T_{CASE} = 25^{\circ}C$)

Forward Current vs. Forward Voltage

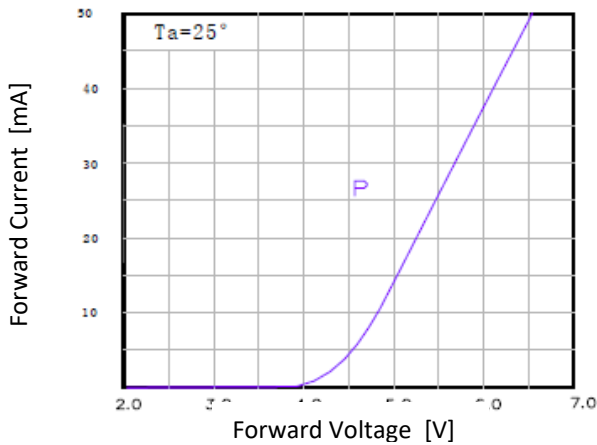

Relative Luminous Int. vs Forward Current

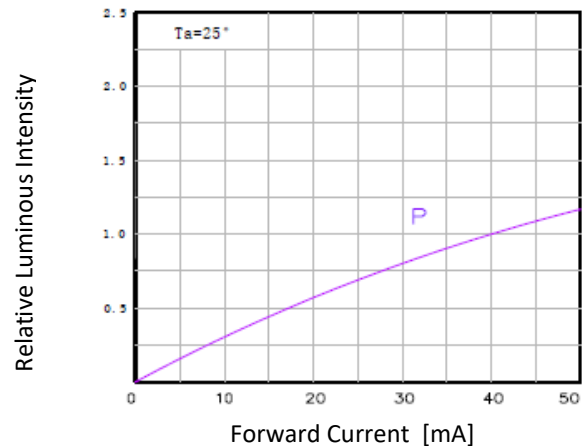

Relative Luminous Int. vs Ambient Temp.

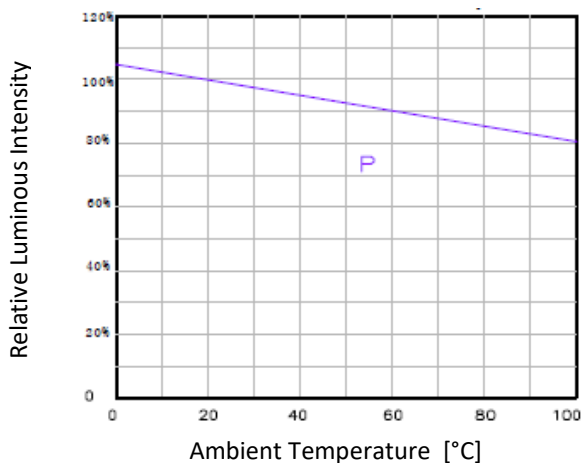

Allowable Forward Current vs. Temp.

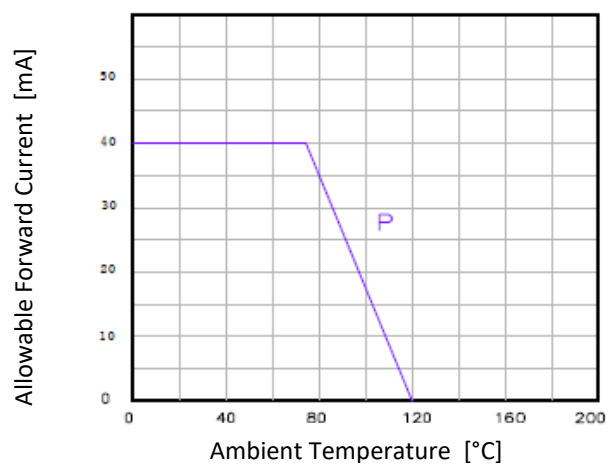

Relative Luminous Int. vs Wavelength

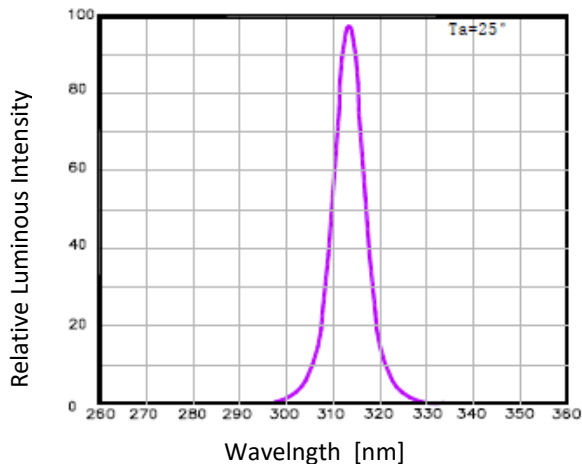

Radiation Characteristics

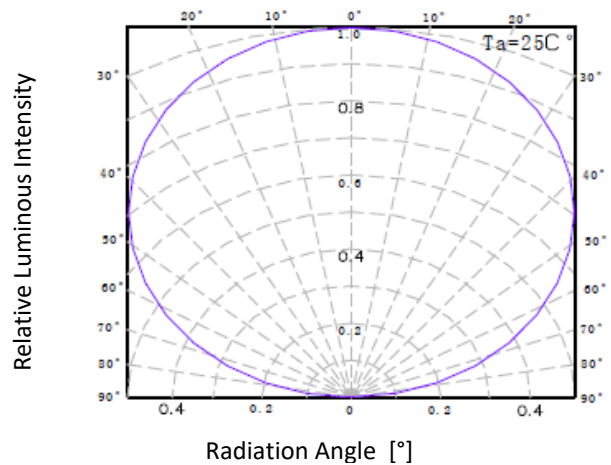



Outline Dimensions

SMD 3535

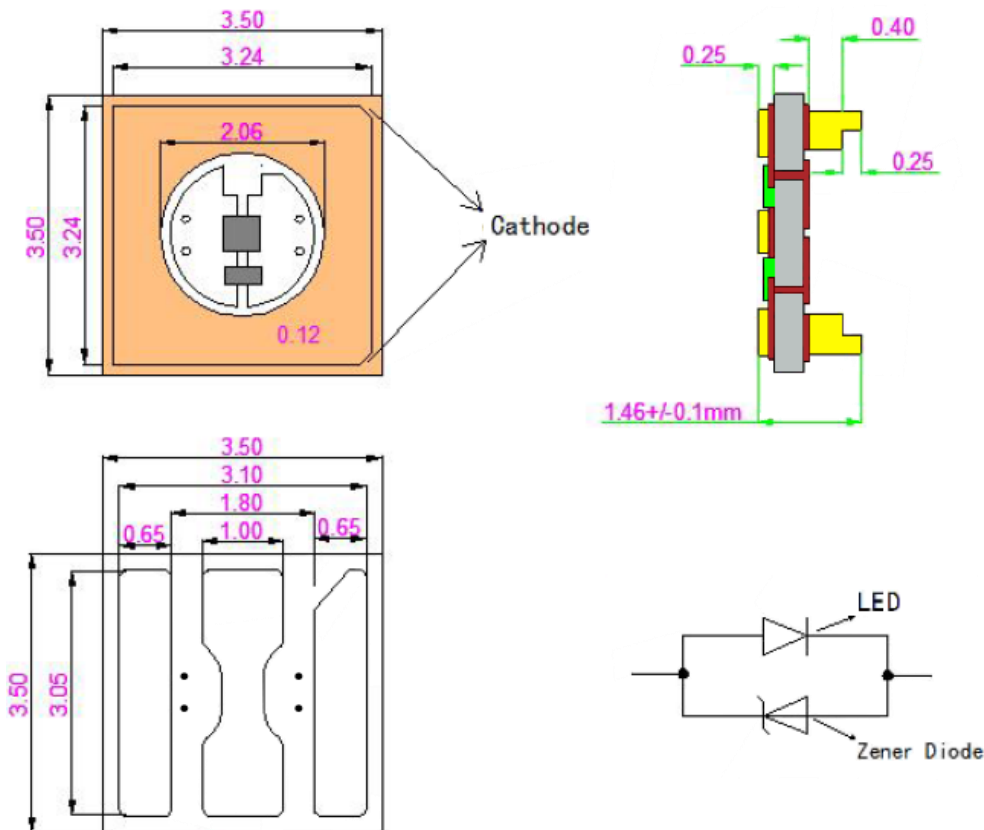





All dimensions in mm, tolerance ±0.1 mm

Accessories

GD35-PCB

Printed **aluminium circuit boards**, designed for easily soldering and mounting of GD35 series LEDs. Available from 8-20 mm in diameter. Ideally suited for prototyping and evaluation.

GD35-PCB-8	GD35-PCB-10	GD35-PCB-14	GD35-PCB-20
			
8mm	10mm	14mm	20mm





Reflow Soldering Information

JEDEC-J-STD-020C Profile

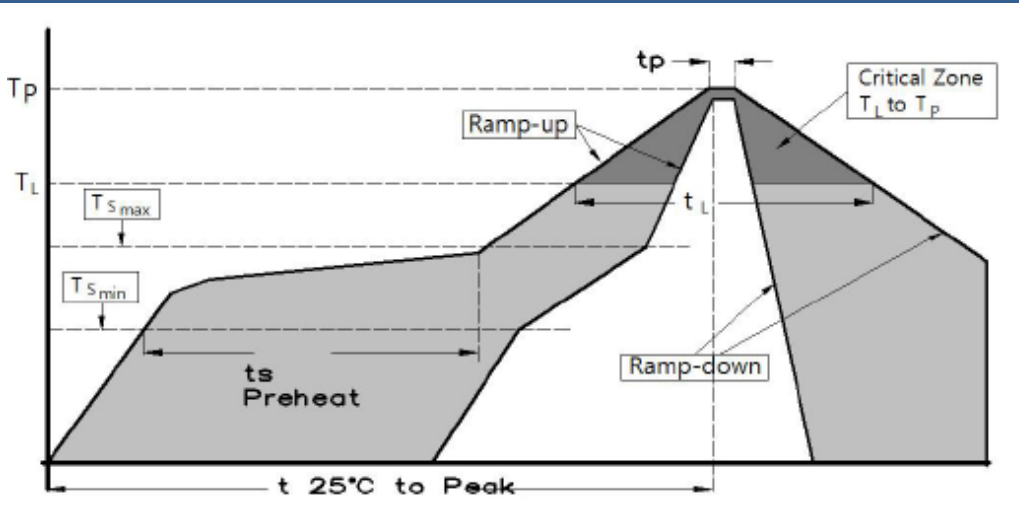

Solder Pad Layout

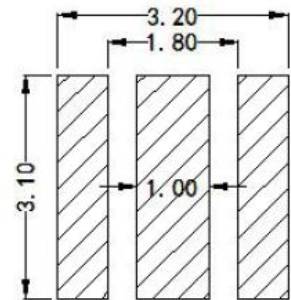

- all dimensions in mm
- drawing not to scale

Heating Rate ($T_{S_{MAX}} - T_P$)	$\leq 3 \text{ }^\circ\text{C/s}$
Minimum Preheat Temp. ($T_{S_{MIN}}$)	130 $^\circ\text{C}$
Maximum Preheat Temp. ($T_{S_{MAX}}$)	150 $^\circ\text{C}$
Preheat Time (t_s)	60 – 120 s
Critical Temp (T_L)	205 $^\circ\text{C}$
Time within Critical (t_L)	≤ 60 s
Soldering Temperature (T_P)	$\leq 240 \text{ }^\circ\text{C}$
Soldering Time (t_p)	≤ 10 s
Time within 5 $^\circ\text{C}$ of max. Soldering Temp.	≤ 30 s
Cool Down Rate	$\leq 6 \text{ }^\circ\text{C/s}$
Time to T_P (from 25 $^\circ\text{C}$)	< 8 min.

- Reflow soldering should not be done more than two times
- LED must not be cooled rapidly after soldering
- When hand soldering, soldering iron temperature must be below 260 $^\circ\text{C}$
- When hand soldering, soldering must be completed within 3 s



Packaging Information

Tape specification

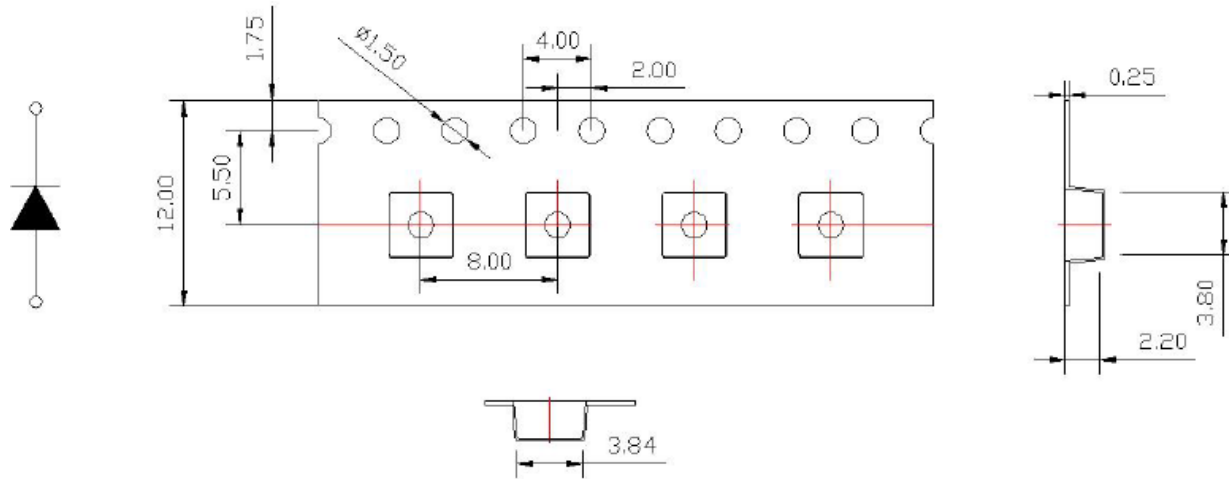

Reel specification (1000pcs)

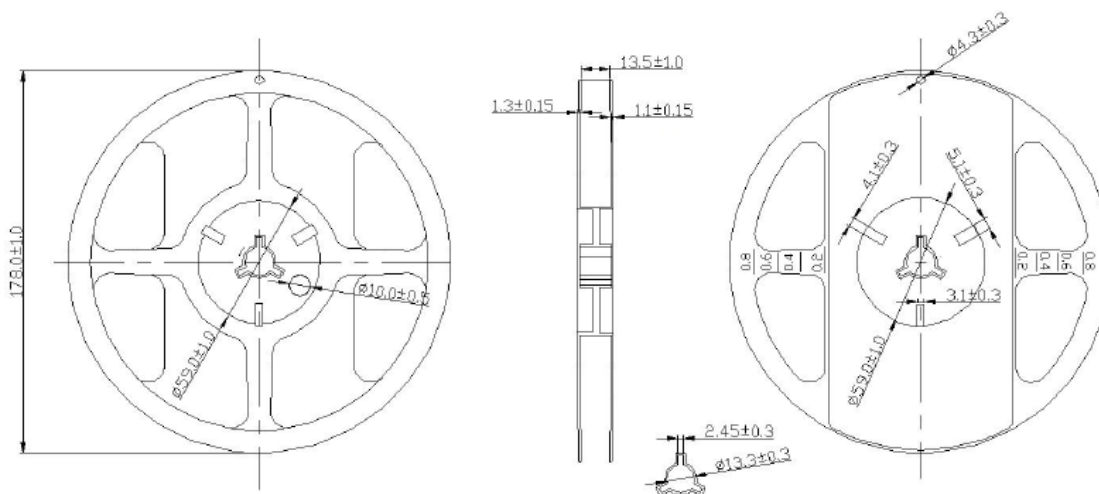

© All Rights Reserved

The above specifications are for reference purpose only and subjected to change without prior notice