



VC850M-H2-TO46FW

- Infrared VCSEL
- 850 nm, 20 mW
- Multi Mode
- TO-46 Can
- Flat window cap



Description

VC850M-H2-TO46FW is a multi mode infrared VCSEL emitting at typically 850 nm with rated output power of 20 mW cw, mounted into a standard TO-46 package and sealed with a flat window cap. The VCSEL works under low forward current and voltage.

Maximum Ratings

Parameter	Symbol	Values		Unit
		Min.	Max.	
Forward Current	I_F		70	mA
Reverse Voltage (@ 10 μ A)	V_F		5	V
Operating Temperature	T_{CASE}	0	+ 60	$^{\circ}$ C
Storage Temperature	T_{STG}	- 40	+ 100	$^{\circ}$ C
Lead Solder Temperature *	T_{SLD}		+ 260	$^{\circ}$ C

* must be completed within 10 seconds

Electro-Optical Characteristics ($T_{CASE}=25^{\circ}$ C)

Parameter	Symbol	Min.	Values		Unit
			Typ.	Max.	
Emission Wavelength	λ_{Peak}	840	850	860	nm
Spectral Width	$\Delta\lambda$			0.85	nm
Optical Output Power	P_O	18	20		mW
Threshold Current	I_{TH}		15		mA
Operating Current	I_F		50		mA
Operating Voltage	V_F		2.1	2.6	V
Breakdown Voltage	V_B		-10		V
Slope Efficiency	η	0.2	0.4		mW/mA
Dynamic Resistance	R_D		10	20	Ω

Thermal Characteristics

Parameter	Symbol	Min.	Values		Test Conditions	Unit
			Typ.	Max.		
I_{TH} Temperature Variation	ΔI_{TH}		10		$T_C=0$ to 60° C	mA
η Temperature Variation	$\Delta\eta / \Delta T$		-0.5		$T_C=0$ to 60° C, 50mA	%/ $^{\circ}$ C
λ Temperature Variation	$\Delta\lambda / \Delta T$		0.06		$T_C=0$ to 60° C, 50mA	nm/ $^{\circ}$ C



Outline Dimensions

TO46FW

TO-46 with flat window

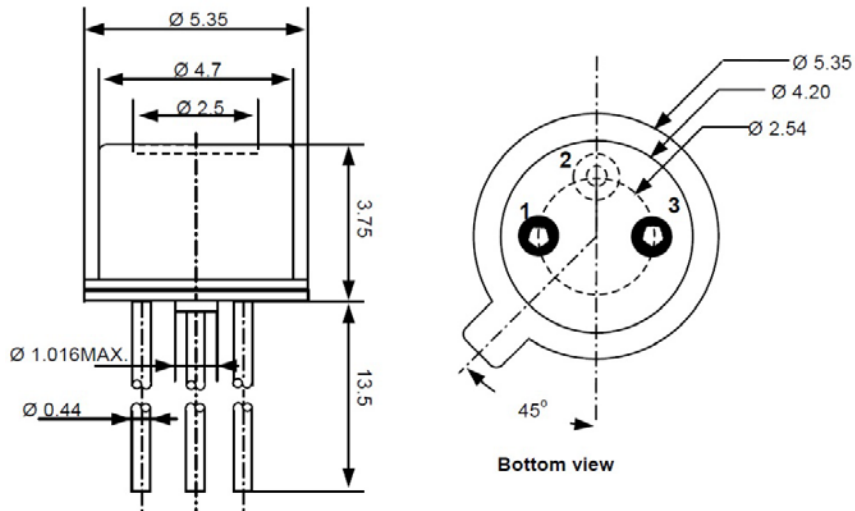

All Dimensions in mm

Electrical Connection

Lead	Description
Pin 1	LD Anode
Pin 2	LD Cathode
Pin 3	n.c.

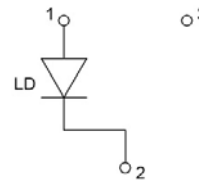

Typical Performance Curves

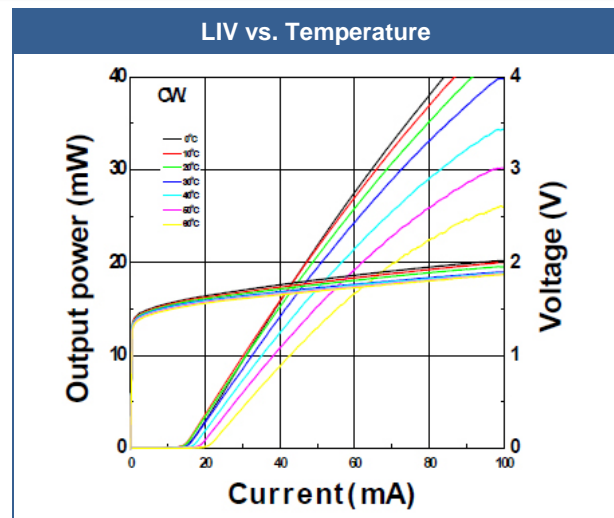
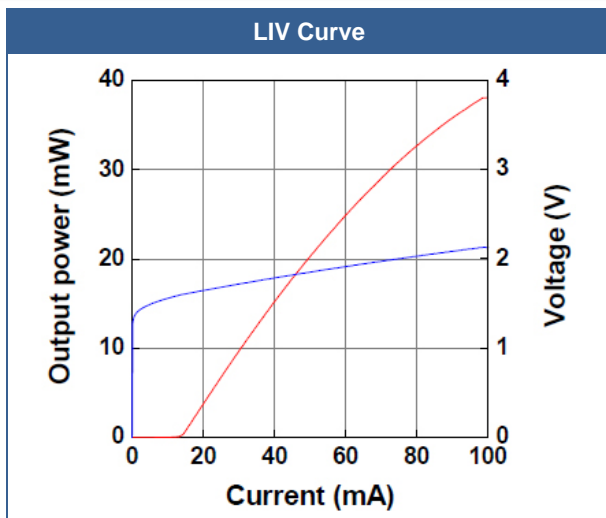



Optical Output Power vs. Temperature

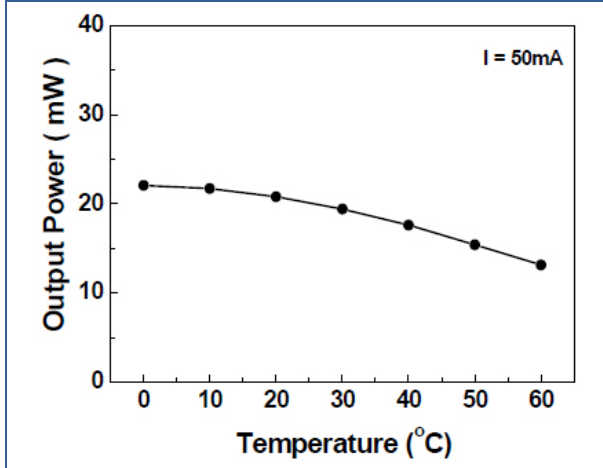

Threshold Current vs. Temperature

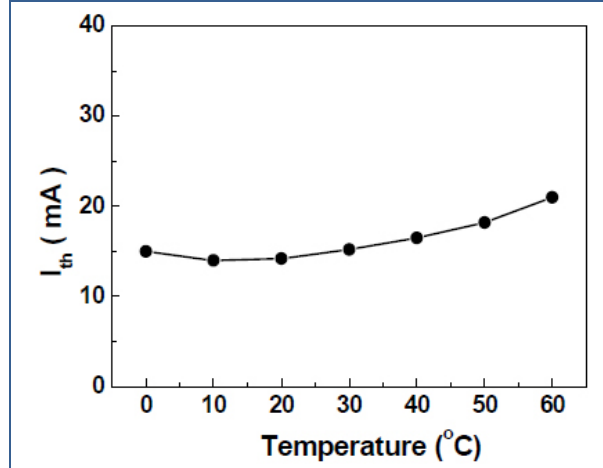

Spectral Emission

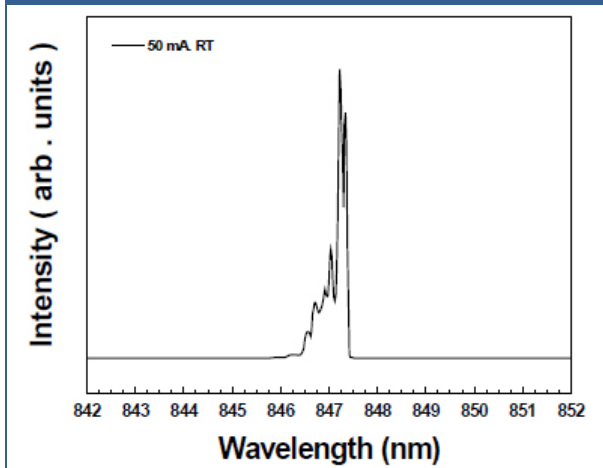

FFP

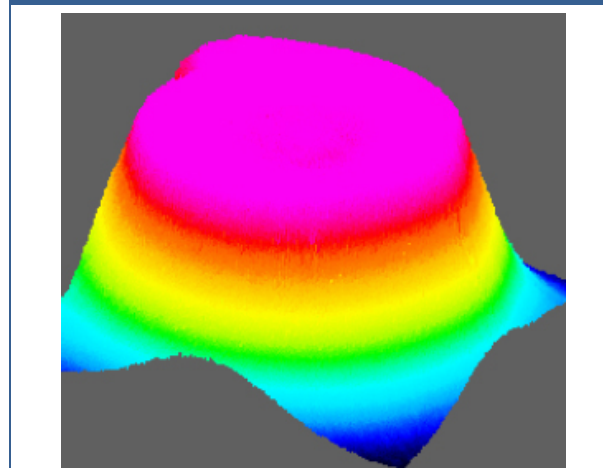

Precautions

Static Electricity:

VCSELs are **sensitive to electrostatic discharge (ESD)**. Precautions against ESD must be taken when handling or operating these VCSELs. Surge voltage or electrostatic discharge can result in complete failure of the device.

Safety Advice:

This VCSEL emits concentrated infrared light which can be **hazardous to the human eye and skin**. This diode is classified as CLASS 3B laser product according to **IEC 60825-1** and **21 CFR Part 1040.10** Safety Standards.



Operation:

Do only operate VCSELs with a current source.

Running these LEDs from a voltage source will result in complete failure of the device.

Current of a LED is an exponential function of the voltage across it. Usage of current regulated drive circuits is mandatory.