

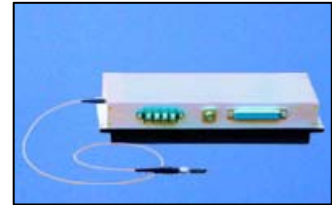

G081PU314W



TECHNICAL DATA

High Power Fiber Coupled Infrared Laser Diode

Features

- CW Output Power: 14 W
- Typical 808 nm Emission Wavelength
- High Reliability
- High Efficiency

Applications

- Laser Pumping
- Medical Usage
- Printing
- Heating
- Material Dealing
- Marking

Specifications (25°C)

Type	G081PU314W	Unit
Optical Specification		
CW Output Power from Fiber P_F	14	W
Center Wavelength Δ_C	808	nm
Wavelength Tolerance	800 – 820	nm
Spectral Width $\Delta\lambda$	< 7 (4)	nm
Wavelength Temperature Coefficient	0.3	nm/°C
Fiber Characteristics		
Fiber Core Size	700	μm
N.A.	0.22	
Fiber Length	1	m
Connector	FC/ST/SMA-905	
Electrical Specification		
Slope Efficiency E_S	> 14	W/A
Threshold Current I_{th}	250	mA
Operation Current I_O	1250	mA
Operation Voltage V_f	< 35	V
Series Resistance R_d	< 3.5	Ω
Package Style	P3-Package	
Absolute Maximum Ratings		
Reverse Voltage V_r	35	V
Operating Temperature T_O	-10 ... 45	°C
Storage Temperature T_{stq}	-40 ... 85	°C





Package Dimensions

P3-Package (Unit:mm)

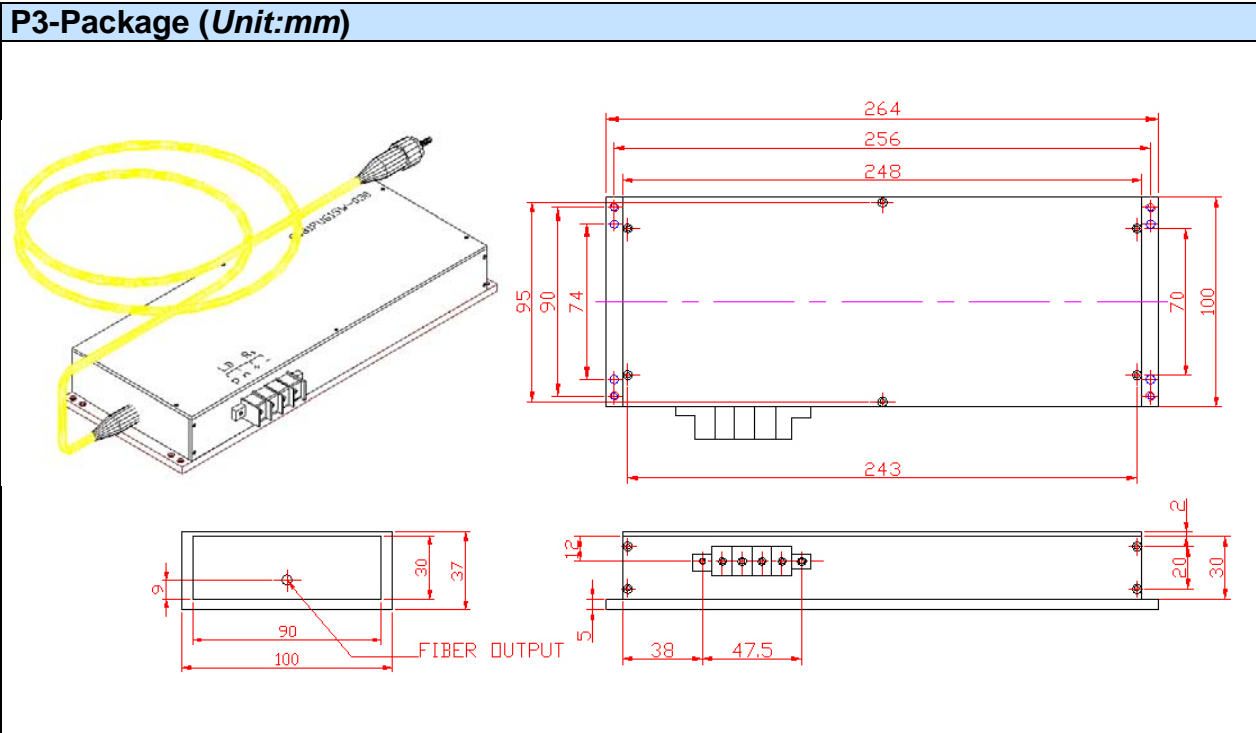



Typical Performance Curves

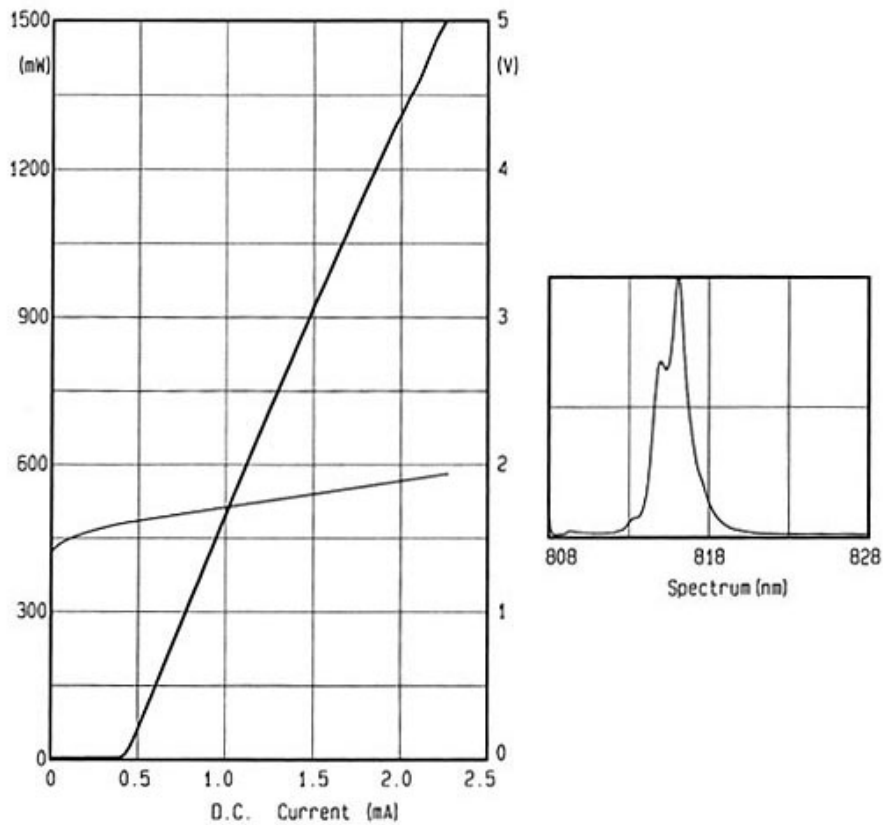
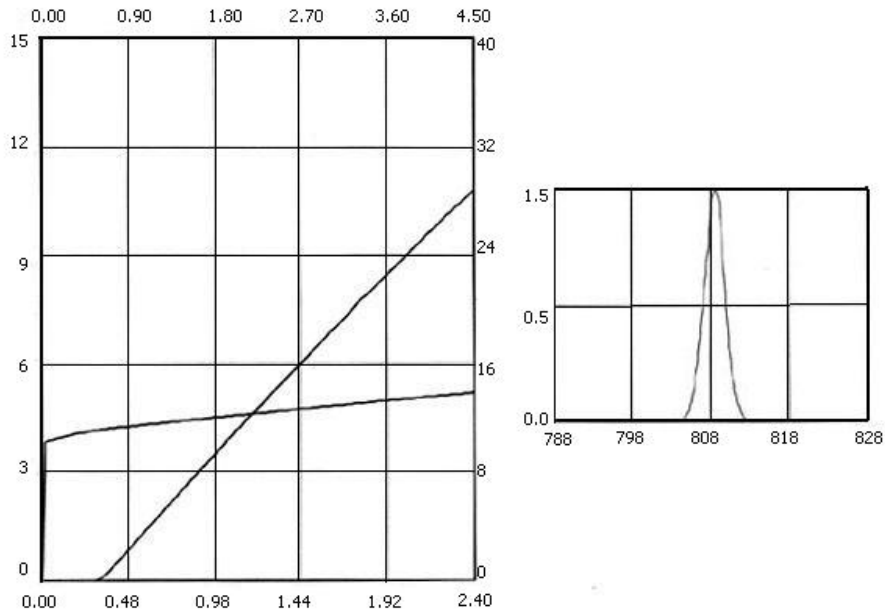



Notes

1. Laser beam is harmful especially for your eyes. Don't look at the laser beam directly.
2. Lifetime of the diode laser varied with the operating temperature inversely. We advise that the TEC cooler should be used to keep the temperature suitable.
3. For turning on the diode laser, please increase the current gradually to the specified operating value. For shutting down the diode laser, please decrease the current to zero gradually, and then turn off the power.
4. Please wear staticproof bracelet when operating.
5. Please connect the pins of the diode laser correctly as the picture shown in the manual.
6. The operating current must less than the rated current. Otherelse the diode laser should be damaged.
7. The fiber facet should be keep clean befor the diode laser is operating.
8. Please use the constant-current source to avoid the surge.
9. Diode laser should be short circuit when stop using.
10. Bend diameter of the fiber must be larger than 4cm temporarily and 8cm permanently.