



ROITHNER LASERTECHNIK GmbH

WIEDNER HAUPTSTRASSE 76
TEL. +43 1 586 52 43 -O. FAX. -44

1040 VIENNA AUSTRIA
OFFICE@ROITHNER-LASER.COM



RLT1370-10MGS-B

- Infrared Laser Diode
- 1370 nm, 10 mW
- DFB
- Single transverse mode
- 5.6mm TO-Can with non-spherical glass lens



Description

RLT1370-10MGS-B is an infrared **distributed feedback (DFB)** laser diode, with **single transverse mode** emission at typically 1370 nm and low operating current. RLT1370-10MGS-B comes in 5.6 mm TO-Can package with non-spherical glass lens and **integrated PD**. A flat window glass version is optionally available.

Maximum Rating* ($T_{CASE} = 25^{\circ}C$)

Parameter	Symbol	Values		Unit
		Min.	Max.	
Reverse Voltage	V_R		2	V
Operating Temperature*	T_{OPR}	- 20	+ 50	$^{\circ}C$
Storage Temperature*	T_{STG}	- 40	+ 85	$^{\circ}C$
Soldering Temperature (max. 3s)	T_{SOL}		+ 260	$^{\circ}C$

* operating close to or outside these conditions may damage the device

Electro-Optical Characteristics ($T_{CASE} = 25^{\circ}C$)

Parameter	Symbol	Values			Unit
		Min.	Typ.	Max.	
Peak Wavelength	λ_P	1367	1370	1380	nm
Optical Output Power	P_O		10		mW
Spectral Width (FWHM)	λ		0.3	2	nm
Operating Voltage	V_F		1.4		V
Threshold Current	I_{th}		5		mA
Operating Current	I_F		60		mA
Reverse Current (PD)	I_{RP}		0.5		mA



Electrical Connection

Pin Configuration

Pin #	Function
Pin 1	PD anode
Pin 2	LD anode (case)
Pin 3	LD cathode
Pin 4	PD cathode

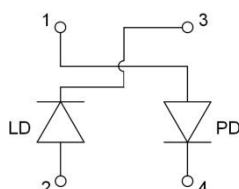

Bottom View

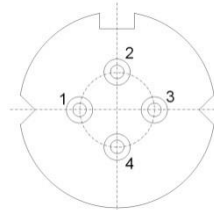



Outline Dimensions

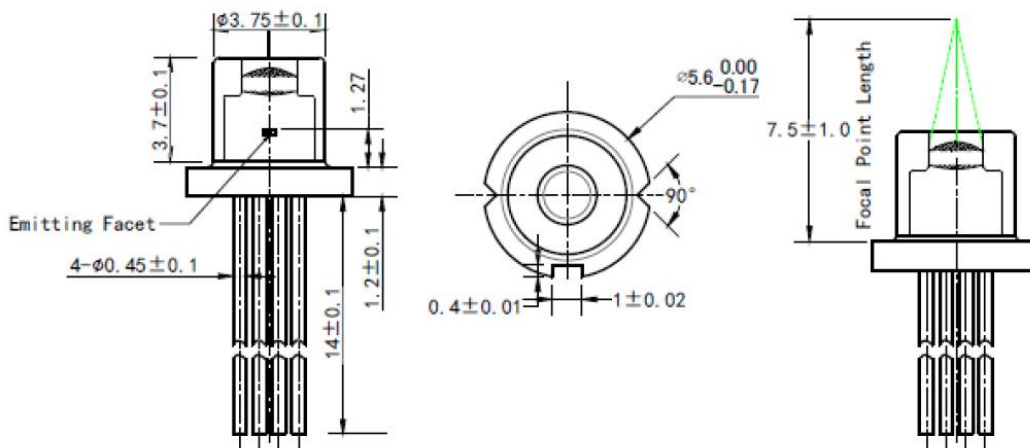

All dimensions in mm

Precautions

Safety

Caution: Laser light emitted from any laser diode may be **harmful to the human eye**. Avoid looking directly into the laser diode's aperture when the diode is in operation.

Note: The use of optical lenses with this laser diode will increase eye hazard



ESD caution

Always do handle laser diodes with extreme care to **prevent electrostatic discharge**, the primary cause of unexpected diode failure. To prevent ESD related failures, it is strongly advised to always **wearing wrist straps**, and **grounding all applicable work surfaces**, when handling laser diodes

Operating Considerations

It is strongly advised to only operate this laser diode with a current source. The current of a laser diode is an exponential function of the voltage across it. **Usage of current regulated drive circuits is mandatory.** Laser diodes may be damaged by excessive drive currents or switching transients

It is advised, to operate the laser diode at the lowest temperature possible, and to never exceed maximum specifications as outlined in the datasheet. Device degradation will accelerate with increased temperature. **Proper heat sinking will greatly enhance stability and life time of the laser diode**