

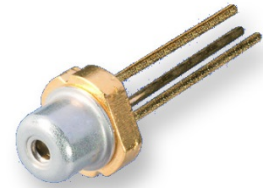

LD-515-30SG

- **Direct Emitting Green Laser Diode**
- **515 nm, 30 mW**
- **Single Transverse Mode**
- **Structure: GaN**



Description

LD-515-30SG is a direct emitting, **GaN based**, 515nm green laser diode in TO38 package **without photodiode**. It offers single transverse mode emission and >100 Mhz modulation bandwidth. It is an efficient radiation source for many applications like **laser projection**, holography, metrology, biomedical application...

Maximum Ratings

Parameter	Symbol	Values		Unit
		Min.	Max.	
Operating Current	I_F		180	mA
Reverse Voltage	V_R		2	V
Operating Temperature	T_{CASE}	+ 20	+ 60	°C
Storage Temperature	T_{STG}	- 40	+ 85	°C
Soldering Temperature	T_{SOLDER}		260	°C
Junction Temperature	T_J		150	°C

Laser Characteristics ($T_{CASE} = 25^\circ C, P_O = 30 \text{ mW}$)

Parameter	Symbol	Values			Unit
		Min.	Typ.	Max.	
Emission Wavelength	λ_{peak}	510	515	530	nm
Optical Output Power	P_O	30			mW
Spectral Width	$\Delta\lambda$		2		nm
Threshold Current	I_{th}		50	75	mA
Operating Current	I_F		120	140	mA
Operating Voltage	V_F		6.7	8.0	V
Beam Divergence (FWHM)	$\Theta_{ } \times \Theta_{\perp}$	4x16	7x22	11x25	deg
Polarization	P_{GR}	20:1			
Modulation Frequency	f		>100		MHz



Performance Characteristics

Optical Output Power

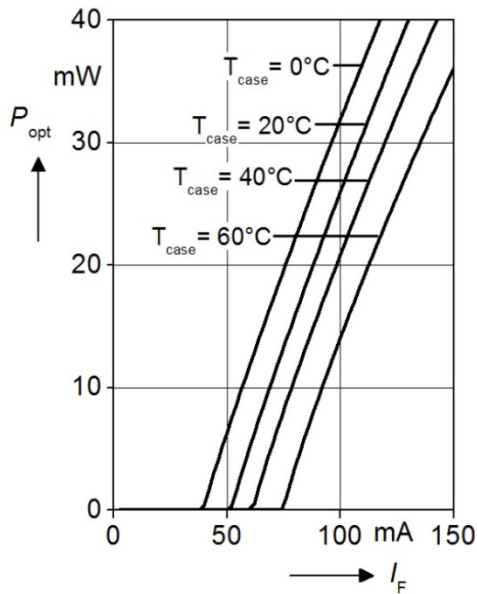

Operating Voltage

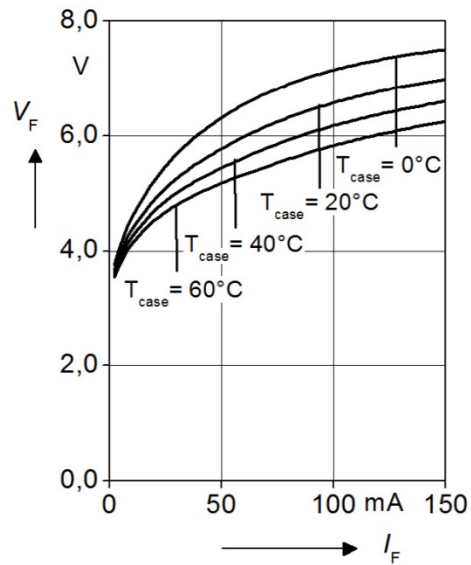

Threshold Current

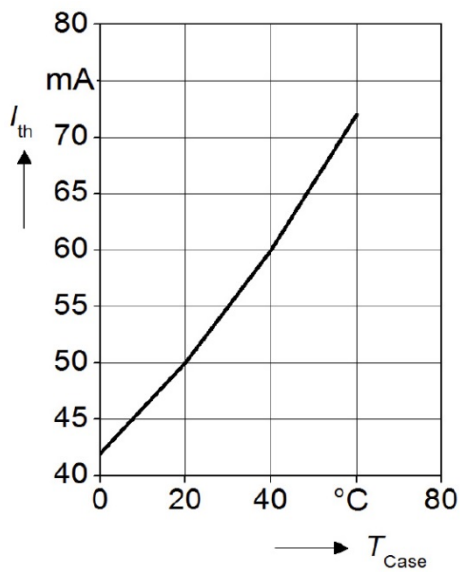

Spectrum

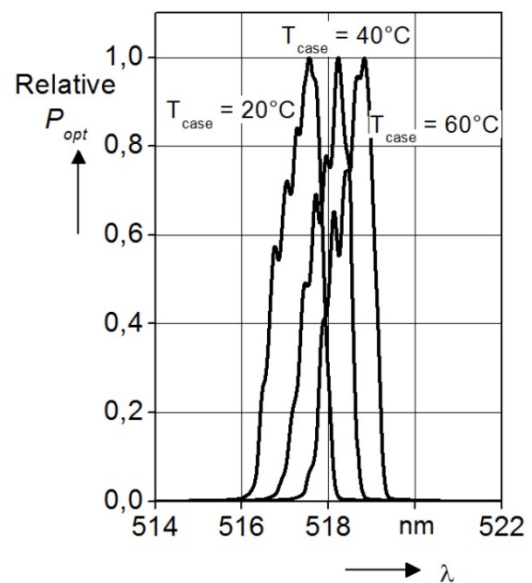



Drawing

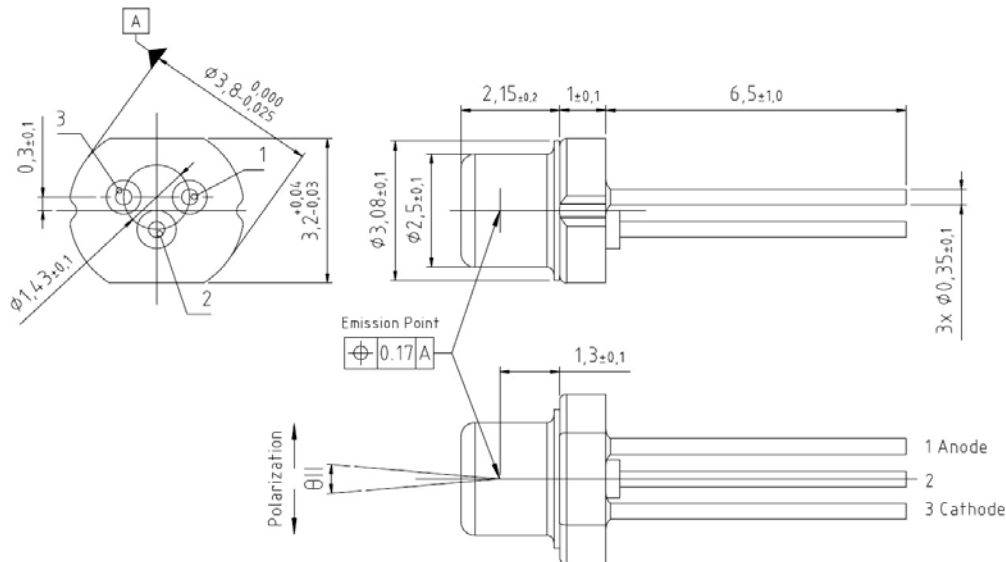

Dimensions in mm

Electrical Connection

Lead	Description
Pin 1	LD Anode
Pin 2	Case
Pin 3	LD Cathode

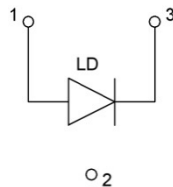

Mounting Instruction

In order to maintain lifetime and stability of the laser diode it is essential to provide efficient heat management. Heat dissipation is possible through the base plate only. For long time stable operation proper contact between laser diode base plate and heat sink is mandatory

Safety Advice

This laser diode emits highly concentrated visible light which can be **hazardous to the human eye**. This diode is classified as **Class 3B laser product** according to **IEC 60825-1**. Actual laser light emitted and precautions necessary strongly depend on mode of operation.