

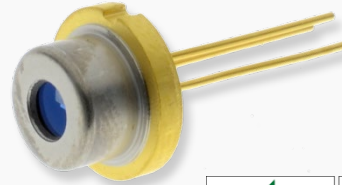

## LD-450-1600MG

- Blue Laser Diode
- 450 nm, 1600 mW
- Multi Transverse Mode
- 5.6mm TO-Can



### Description

**LD-450-1600MG** is a blue multi transverse mode laser diode emitting at typically 450nm with rated output power of 1600 mW CW, in a standard 5.6 mm TO package.

### Maximum Ratings

Parameter	Symbol	Values		Unit
		Min.	Max.	
Operating Current	$I_F$		1.6	A
Reverse Current	$I_R$		20	mA
Operating Temperature	$T_{CASE}$	+ 10	+ 70	°C
Storage Temperature	$T_{STG}$	- 40	+ 85	°C
Soldering Temperature	$T_{SOLDER}$		260	°C
Junction Temperature	$T_J$		150	°C

### Laser Characteristics ( $T_{CASE} = 25^{\circ}C$ , $I_F = 1.2 A$ )

Parameter	Symbol	Values			Unit
		Min.	Typ.	Max.	
Emission Wavelength	$\lambda_{peak}$	440	450	460	nm
Optical output power	$P_O$	1.3	1.6		W
Threshold Current	$I_{th}$		0.2	0.3	A
Operating Current	$I_F$		1.2	1.5	A
Operating Voltage	$V_F$		4.8	6.0	V
Beam Divergence (FWHM)	$\theta_{  } \times \theta_{\perp}$	- x 19	7 x 23	- x 27	deg
Polarization	$P_{GR}$		100:1		
Thermal resistance	$R_{th}$		15		K/W



## Performance Characteristics

### Optical Output Power

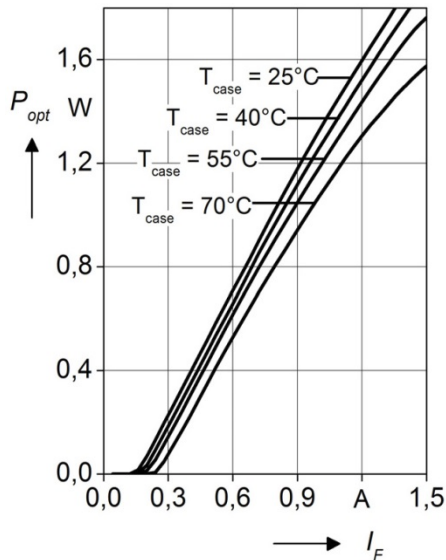

### Operating Voltage

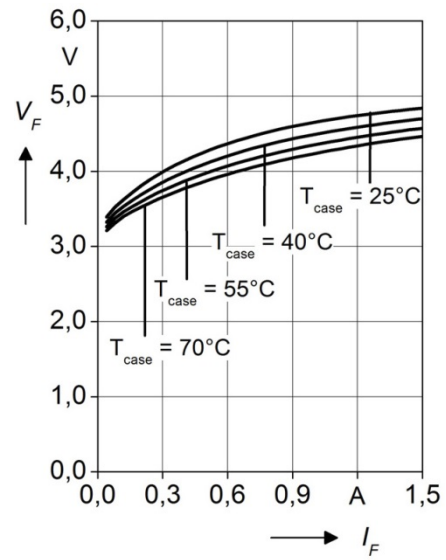

### Threshold Current

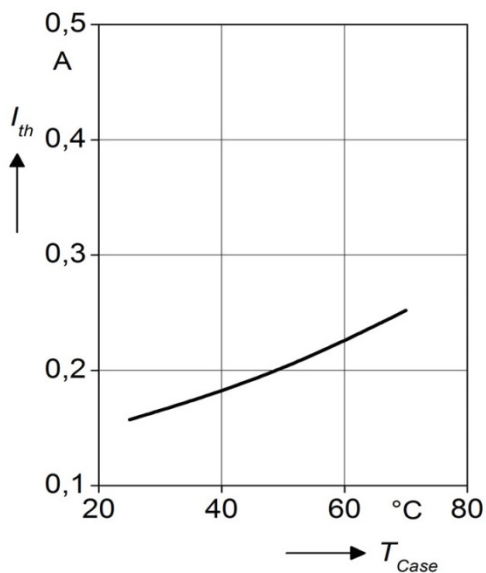

### Spectrum

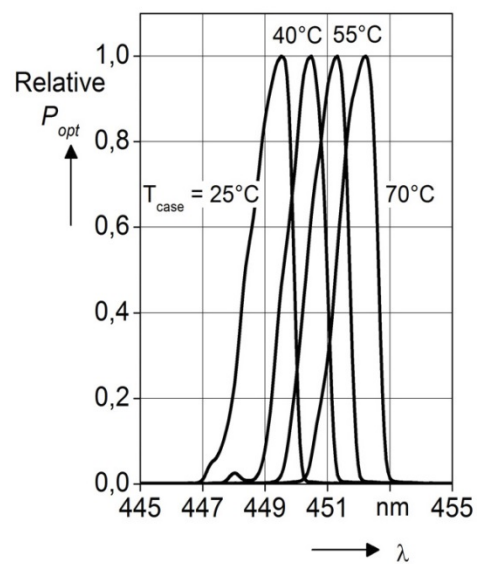



## Drawing

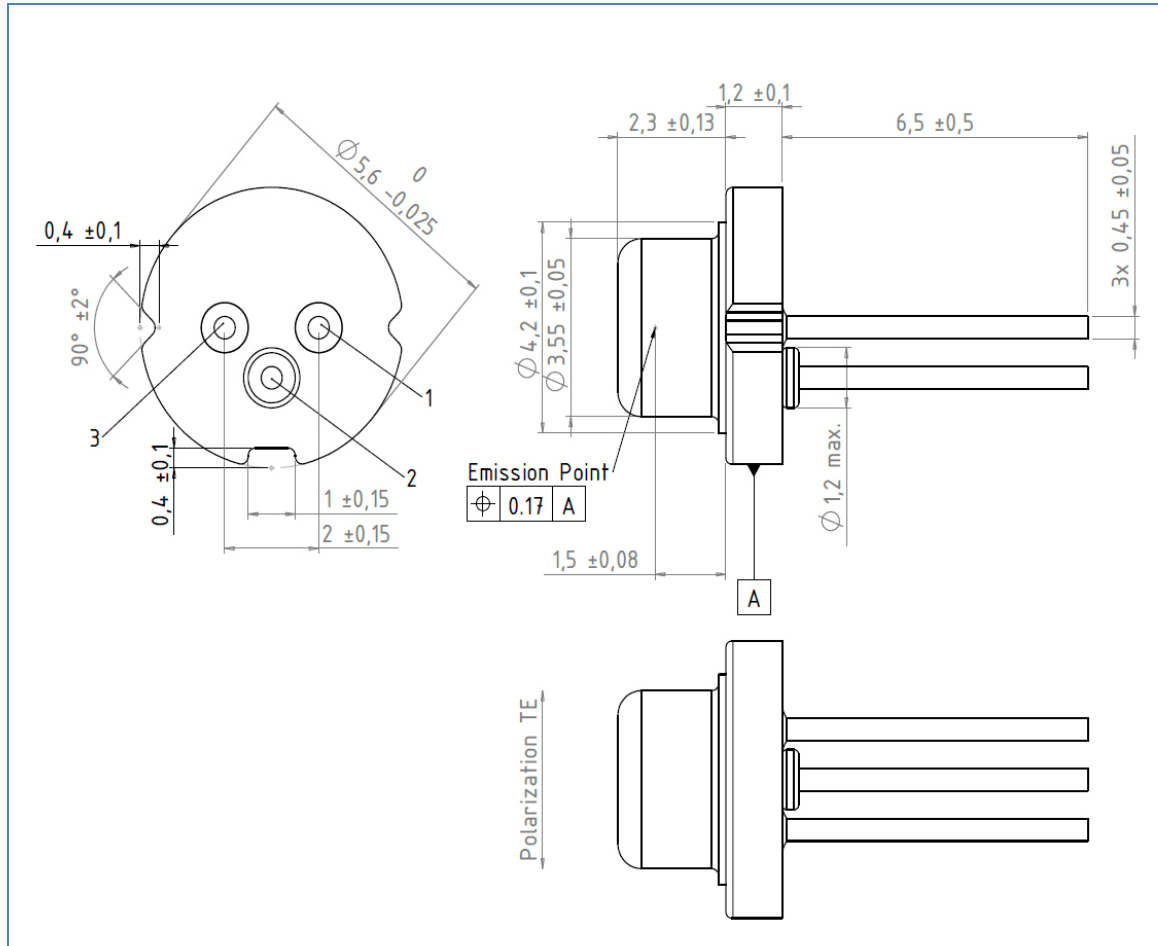

All dimensions in mm

## Electrical Connection

Lead	Description
Pin 1	LD anode
Pin 2	Case
Pin 3	LD cathode

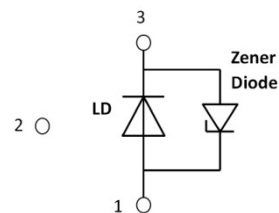



## ESD Caution

Always do handle laser diodes with extreme caution to prevent electrostatic discharge, the primary cause of unexpected diode failure. ESD failures can be prevented by always wearing wrist straps, only using a grounding workplace, and following strict anti-static guidelines when handling the laser diode



## Safety Advice

This laser diode emits highly concentrated blue light which can be **hazardous to the human eye and skin**. This diode is classified as **CLASS 4 laser product** according to IEC 60825-1 and 21 CFR Part 1040.10 Safety Standards.

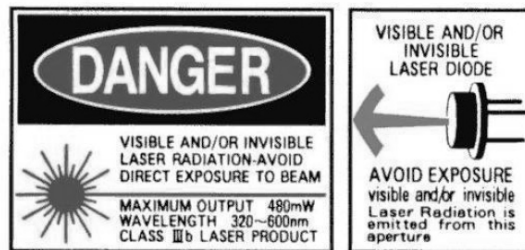

This product is comply with 21 CFR Part 1040.10

## Operating Considerations

Operating the laser diode outside of its maximum ratings may cause failure or a safety hazard. The diode may be damaged by excessive drive currents or switching transients. If the diode is operated using a power supply, it is strongly recommended to connect the diode with the output voltage set to zero. The voltage should then be increased slowly and with great caution, while at the same time carefully monitoring the laser diodes output power and drive current. The laser diode will show accelerated degradation with increased temperature, and it is advised to keep the case temperature low therefor, by means of heat sinking the device.